



Speed



www.silca.biz



Speed

New, fast, compact, precise and user-friendly, Speed is perfect for key cutters who have just entered the key duplication business, but also for experienced Duplicating Centres that require a precise and user-friendly machine with a wide range of optional accessories.



Speed

Speed is the new Silca key cutting machine for the duplication of cylinder, vehicle and cruciform keys.



Speed is engineered in conformity with CE mark European standards.

* Standard only on 120V version.



Speed - **Plus**

- Precise.
- Easy to use.
- Versatile.
- Comfortable.
- Compact.
- Efficient.
- Safe.



Speed – Main Features

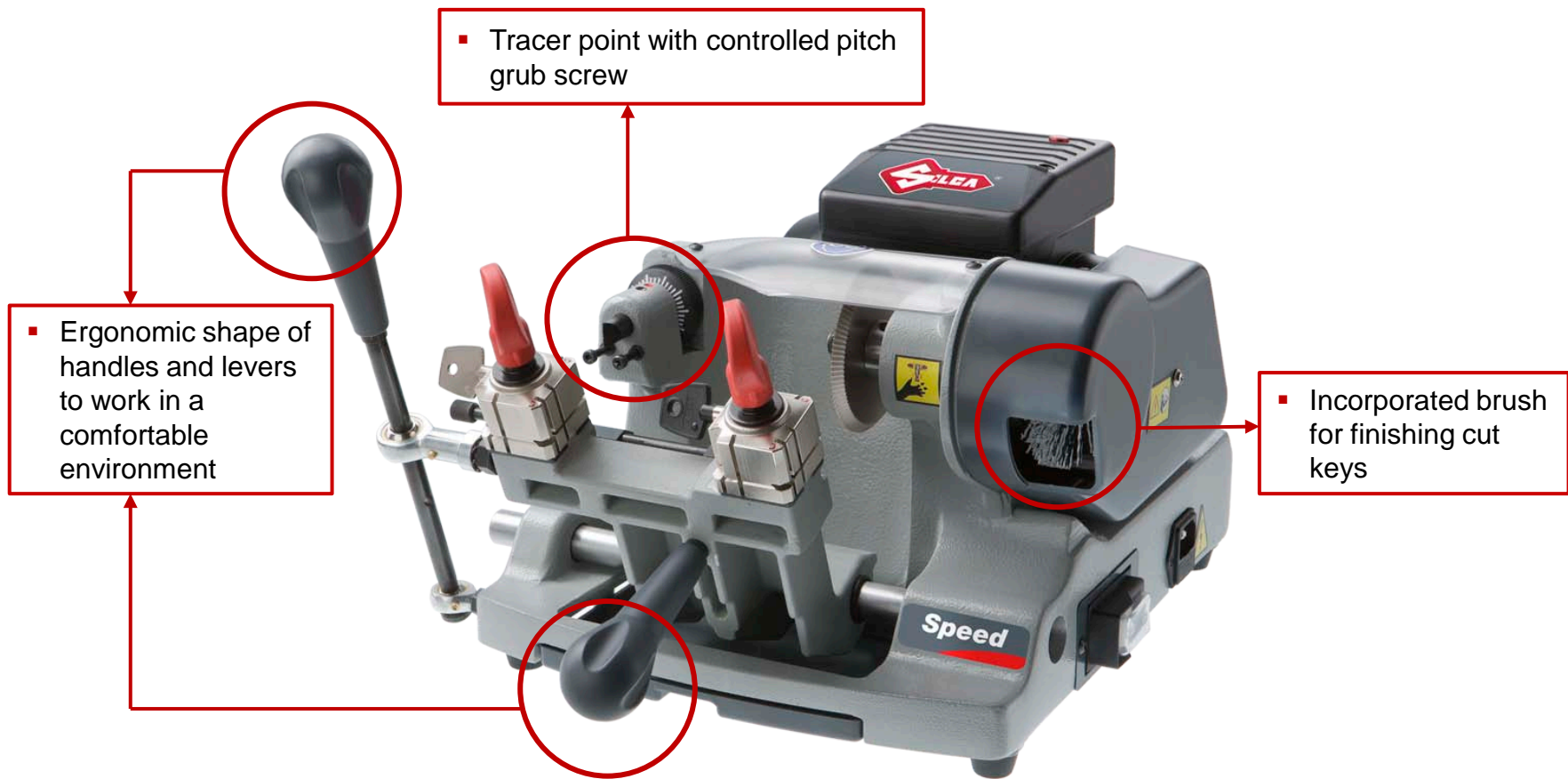

▪ Ergonomic shape of handles and levers to work in a comfortable environment

▪ Tracer point with controlled pitch grub screw

▪ Incorporated brush for finishing cut keys



Speed - Main Features

- Wide working space to operate comfortably

- Carter

- Protection of moving parts

- Four-face rotating clamps to duplicate a high number of keys

- Removable chipping tray



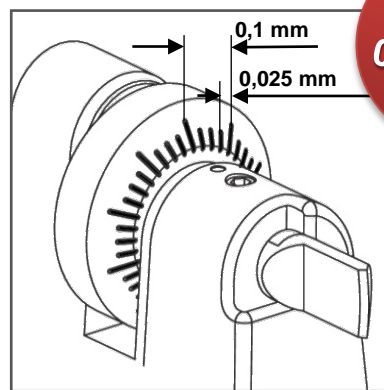
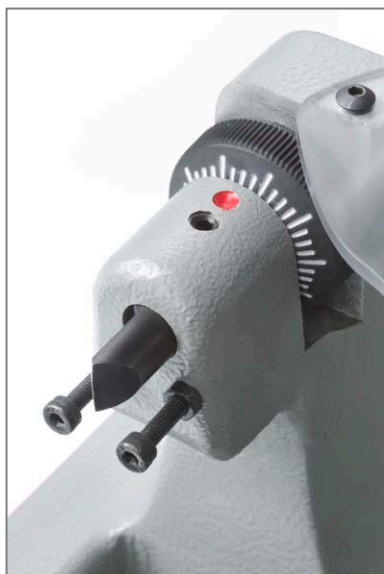

0,1 mm
0,025 mm

Speed - Plus

Precision by hundredth millimetre

■ Perfect calibration of the depth of the machine thanks to the tracer point with controlled pitch grub screw.

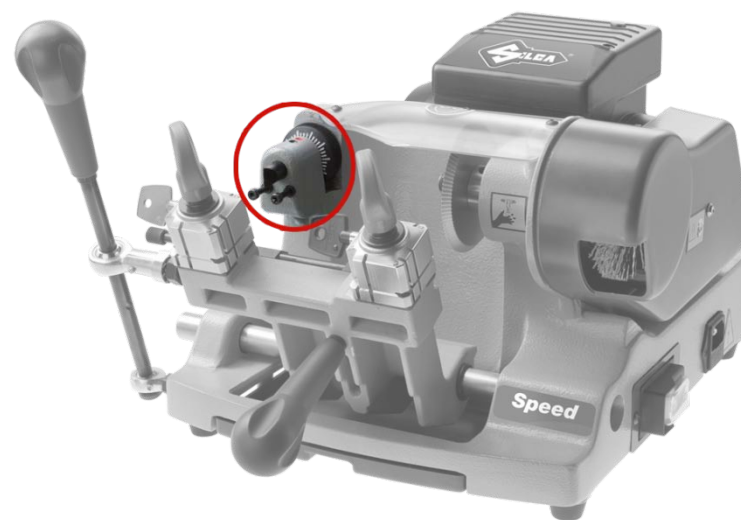

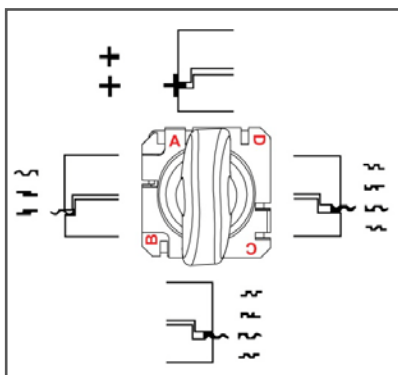

Speed - Plus

Great versatility

- The four-face rotating clamps enable the machine to reproduce a high-number of keys and allow to block them both on the back and on the profile side.

FOUR-FACE
CLAMPS

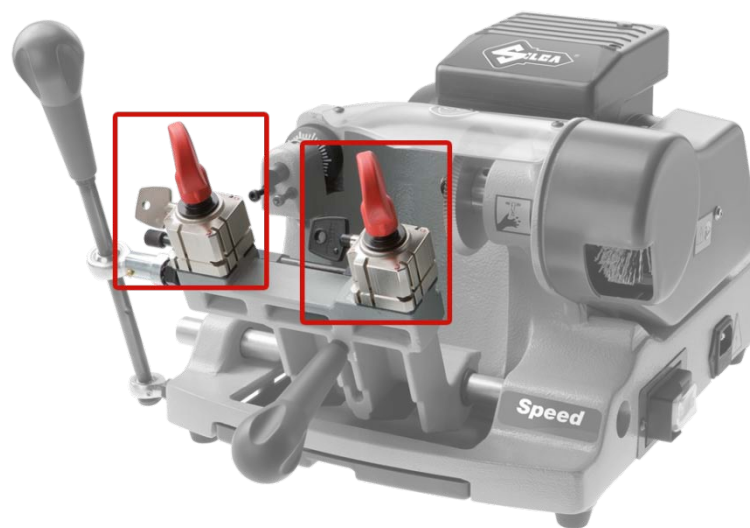



Speed - Plus

Guaranteed Comfort

- Ergonomic shape of handles and levers and innovative design to work in a comfortable environment.





300 mm
11.81"

460 mm - 18.11"



330 mm - 12.99"



400 mm - 15.74" max.
levers included

Speed - Plus

Space-saving

■ Compact dimensions of the machine to save space and better organise the work station. Speed can adapt to any Duplicating Centre, Locksmith or Shoebar.

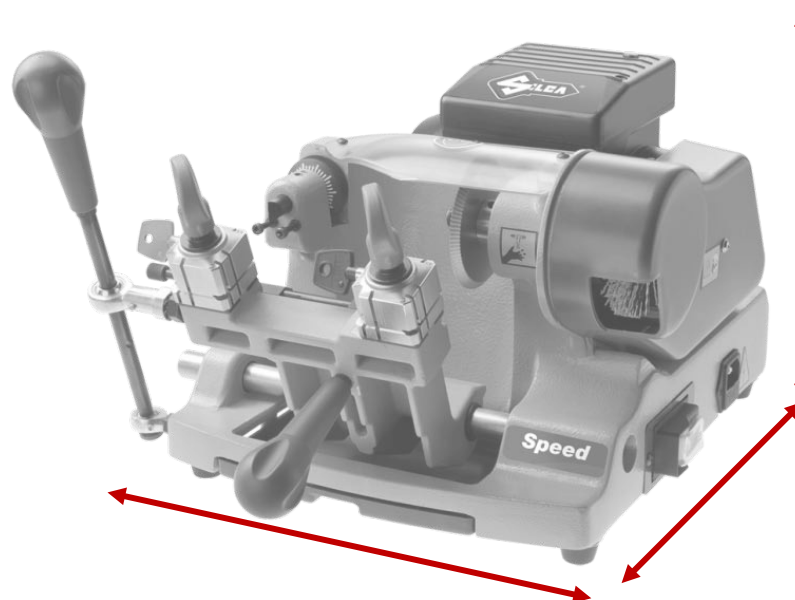



Speed - Plus

Operative Efficiency

■ Efficiency and cleanliness of the work station are ensured by the incorporated brush for finishing cut keys and the removable chipping tray.

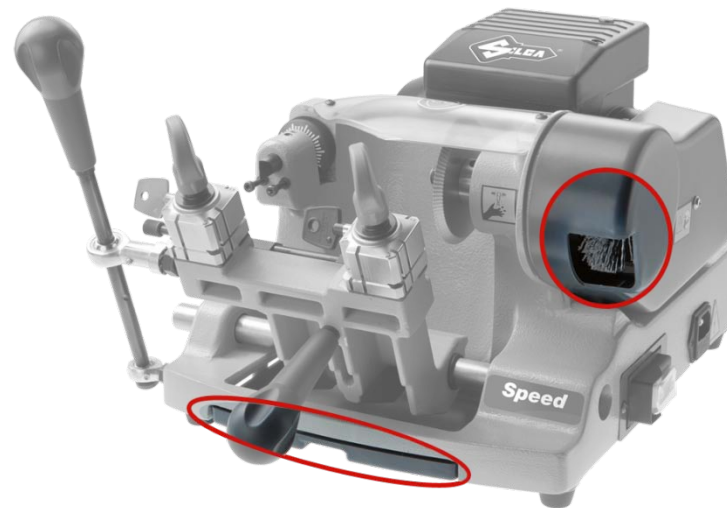



Speed - Plus

Protection

- Carter.
- Protection of moving parts.



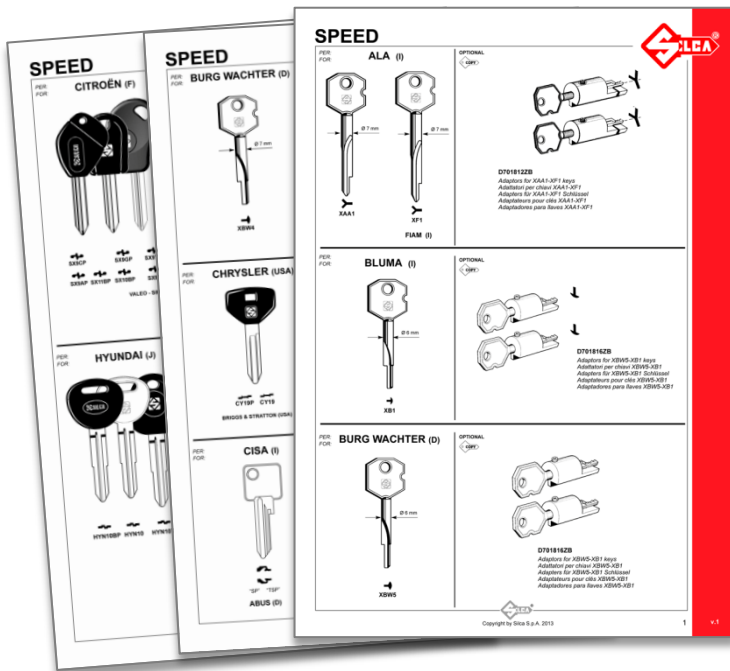

**RANGE OF
OPTIONAL
ACCESSORIES**

Speed - Plus *Optional Accessories*

- Wide range of optional accessories to further enlarge the number of keys that can be duplicated.

Find out all of the details in Silca's Optional Accessories Guide.

Range continually updated



Speed – Optional Adaptors

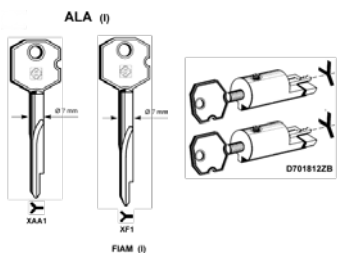

Adaptors for XAA1-XF1 keys

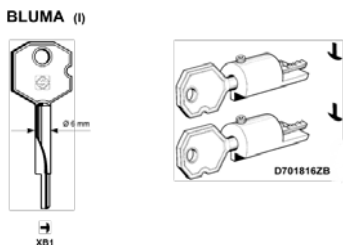

Adaptors for XBW5-XB1 keys

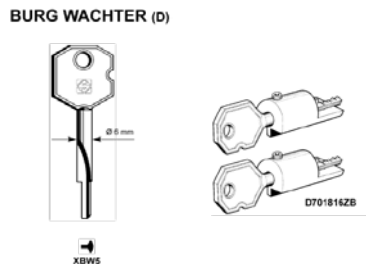

Adaptors for XBW5-XB1 keys

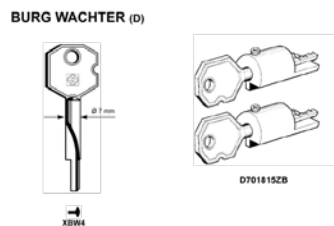

Adaptors for XBW4 keys

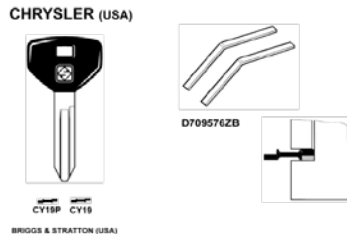

Pair of shims

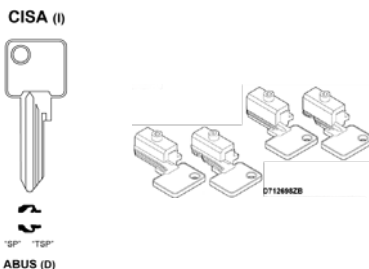

Adaptors for SP e TSP keys

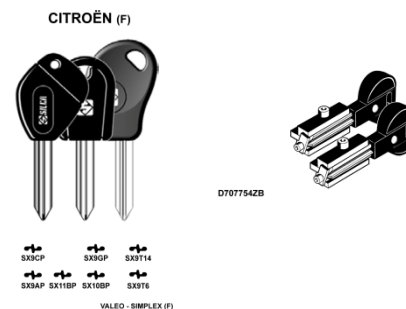

Adaptors for SIMPLEX keys

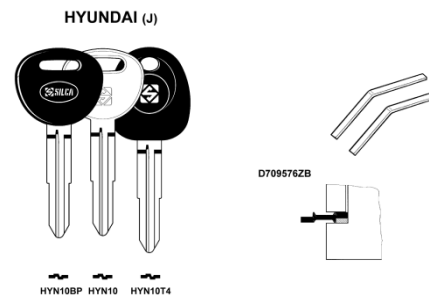

Pair of shims



Technical Data	
Motor	Single phase and speed 230V - 50/60Hz and 120V - 60Hz
Cutter	HSS Super Rapid Steel
Movements	By ball joint on rectified carriage
Standard clamp	Four-face rotating
Maximum length of cuts	42 mm (1.65")
Dimensions	Width: 400 mm (15.74") Depth: 460 mm (18.11") Height: 300 mm (11.81")
Weight	14 Kg (30.8 lb)



www.silca.biz

In compliance with current regulations relating to industrial property, we hereby state that the trade-marks or trade names mentioned in this document are the exclusive property of authorized manufacturers of locks and users. Said trade-marks or trade names are nominated only for the purposes of information so that any lock for which our keys are made can be rapidly identified. This document is reserved exclusively for professional key cutters who use Silca products. / All information and illustrations in this document are for guidance only. Silca reserves the right to alter products designs, dimensions or info to improve the products quality. The contents of this document are fully protected by Copyright and may not be copied or reproduced in any form, without written permission from Silca S.p.A. Any controversy shall be settled by the Courts of Justice where the company has its headquarters, with express exclusion of any other court.