

NEW KEYS COLLECTION

2024
FEBRUARY

NR.
02



NETWORK WITH US













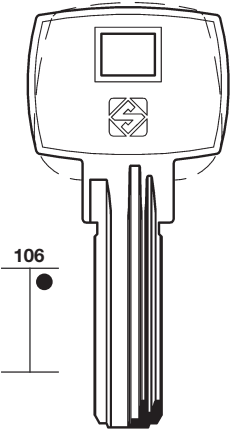

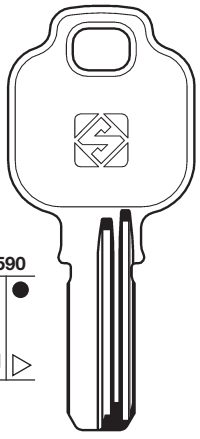

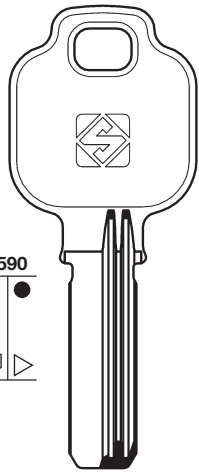

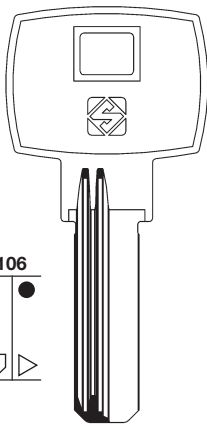

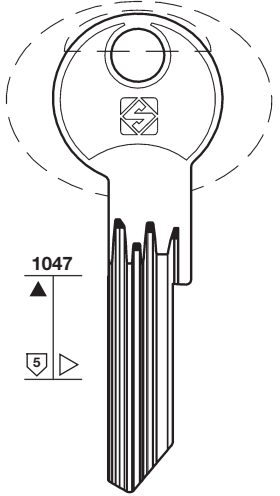
2024 NEW KEYS COLLECTION

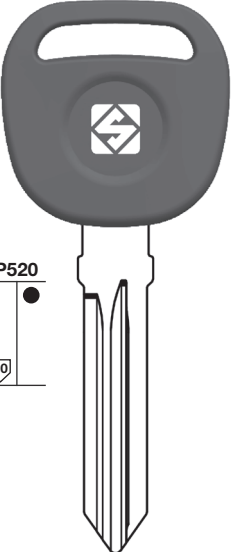
NEW KEYS

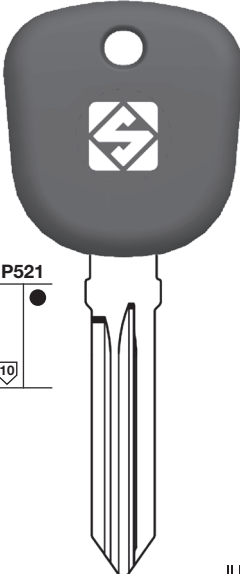

Silca key blanks are compatible with third party manufacturers' cylinders specified here below:

AL AHRAM*	DABEL*			
 <p>NEW</p> <p>106</p>  <p>AHR4</p>  <p>8 052782 041711</p> <p>Box of 50</p>	 <p>1590</p>  <p>DBL1</p>  <p>8 052782 042084</p> <p>Box of 50</p>	 <p>1590</p>  <p>DBL3</p>  <p>8 052782 043449</p> <p>Box of 50</p>	 <p>106</p>  <p>DBL2R</p>  <p>8 052782 042091</p> <p>Box of 50</p>	<p>AL AHRAM (EG)</p> <p>DABEL (RS)</p> <p>FAB (CZ)</p> <p>GENERAL MOTORS (US)</p>
FAB*	GENERAL MOTORS*			
 <p>1047</p>  <p>FB143X</p>  <p>8 052782 042503</p> <p>Box of 50</p>	 <p>NEW</p> <p>P520</p>  <p>B111P</p>  <p>8 052782 041735</p> <p>Box of 25</p>	 <p>NEW</p> <p>P521</p>  <p>B111TE</p>  <p>8 052782 042602</p> <p>Bag of 1</p>  <p>8 052782 042619</p> <p>Bag of 5</p>	<p>(*) This is a trademark of a third party not affiliated nor linked with Silca S.p.A. or the dormakaba Group. Silca S.p.A. and dormakaba Group do not own any intellectual property right nor have been granted any license with regard to such trademark, which is hereby used only to indicate the intended purpose of Silca's products.</p>	















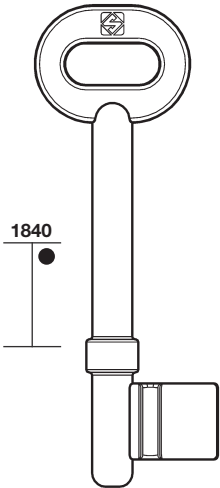

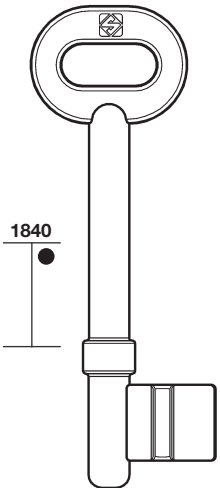

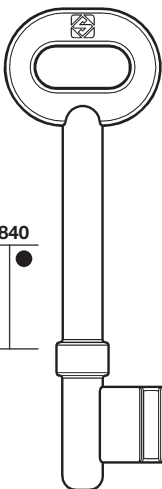
2024 NEW KEYS COLLECTION

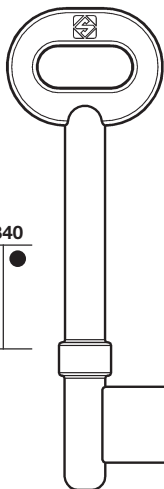
NEW KEYS

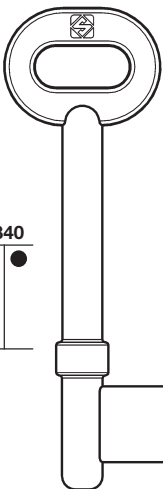

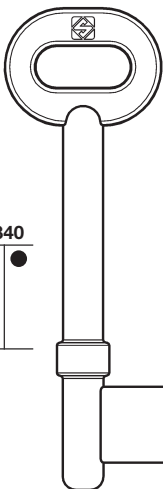
Silca key blanks are compatible with third party manufacturers' cylinders specified here below:

KYMCO*	LEGGE*			
 <p>NEW</p> <p>Magnetic key</p> <p>Model: PEOPLE S Year: 2012-2017</p> <p>Model: X-TOWN CT Year: from 2017</p>   <p>KYM5MP</p>  <p>8 052782 044200</p> <p>Box of 10</p>	 <p>1840</p>  <p>6LEG1-B1</p>  <p>8 052782 039664</p> <p>Box of 25</p>	 <p>1840</p>  <p>6LEG1-B2</p>  <p>8 052782 039671</p> <p>Box of 25</p>	<p>KYMCO (KR)</p> <hr/> <p>LEGGE (GB)</p> <hr/>	
LEGGE*				
 <p>1840</p>  <p>6LEG1-B3</p>  <p>8 052782 039688</p> <p>Box of 25</p>	 <p>1840</p>  <p>6LEG1-B4</p>  <p>8 052782 039695</p> <p>Box of 25</p>	 <p>1840</p>  <p>6LEG1-B5</p>  <p>8 052782 040608</p> <p>Box of 25</p>	 <p>1840</p>  <p>6LEG1-B6</p>  <p>8 052782 040615</p> <p>Box of 25</p>	<p>(*) This is a trademark of a third party not affiliated nor linked with Silca S.p.A. or the dormakaba Group. Silca S.p.A. and dormakaba Group do not own any intellectual property right nor have been granted any license with regard to such trademark, which is hereby used only to indicate the intended purpose of Silca's products.</p>



2024 NEW KEYS COLLECTION

NEW KEYS

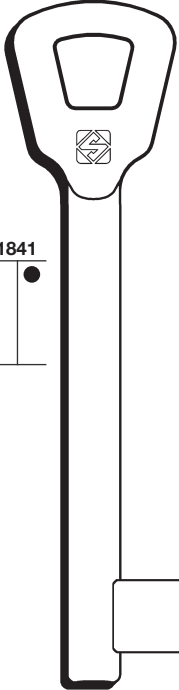
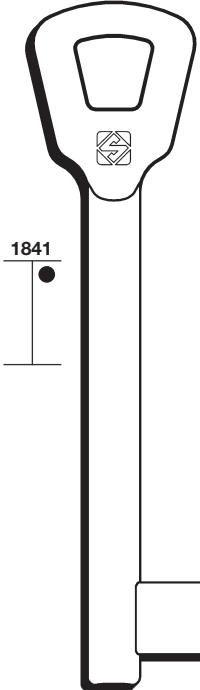
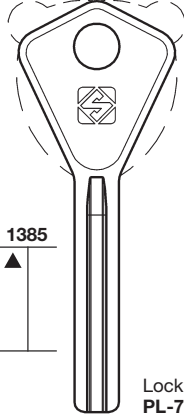
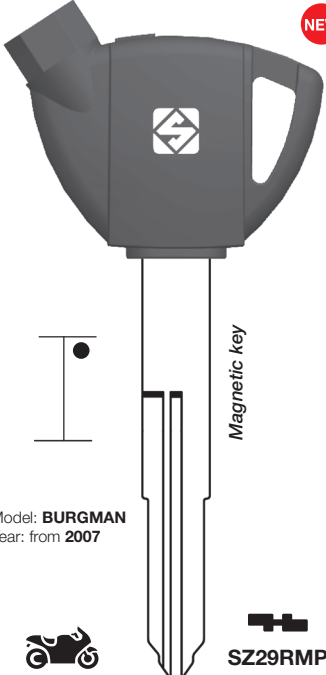
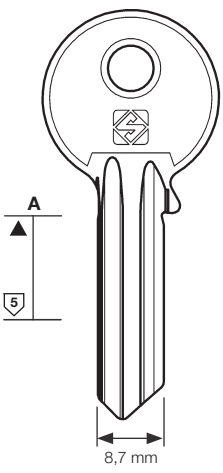

Silca key blanks are compatible with third party manufacturers' cylinders specified here below:

NEMEF*		POWERLOCK*	
 <p>1841</p> <p>6NFH2L</p> <p>8 052782 041377</p> <p>Box of 25</p>	 <p>1841</p> <p>6NFH4L</p> <p>8 052782 041384</p> <p>Box of 25</p>	 <p>1385</p> <p>Lock Systems: PL-700</p> <p>POW1</p> <p>70 mm</p> <p>8 052782 042039</p> <p>Box of 50</p>	<p>NEMEF (NL)</p> <p>POWERLOCK (DE)</p> <p>SUZUKI (JP)</p> <p>UNIVERSAL</p>
SUZUKI*		UNIVERSAL*	
 <p>NEW</p> <p>Magnetic key</p> <p>Model: BURGMAN Year: from 2007</p> <p>SZ29RMP</p> <p>8 052782 044217</p> <p>Box of 10</p>	 <p>NEW</p> <p>A</p> <p>5</p> <p>8,7 mm</p> <p>UL066</p> <p>8 052782 043746</p> <p>Box of 100</p>	<p>(*) This is a trademark of a third party not affiliated nor linked with Silca S.p.A. or the dormakaba Group. Silca S.p.A. and dormakaba Group do not own any intellectual property right nor have been granted any license with regard to such trademark, which is hereby used only to indicate the intended purpose of Silca's products.</p>	



2024 NEW KEYS COLLECTION

NEW KEYS



Silca key blanks are compatible with third party manufacturers' cylinders specified here below:

VACHETTE*

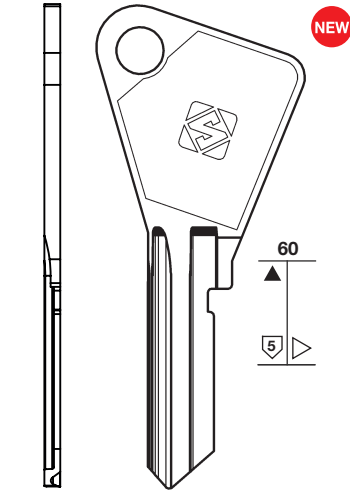

Shoulder milling view



VAC2SM



8 052782 033013

Box of 50

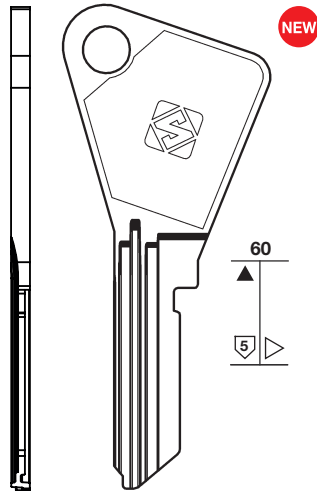

Shoulder milling view



VAC48SM



8 052782 032924

Box of 50

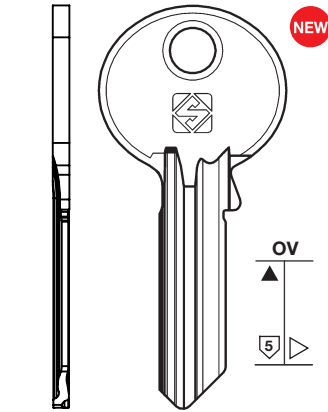

Shoulder milling view



VAC151SM



8 052782 032894

Box of 50

VACHETTE (FR)

YALE (GB)

ZEISS IKON (DE)

YALE*

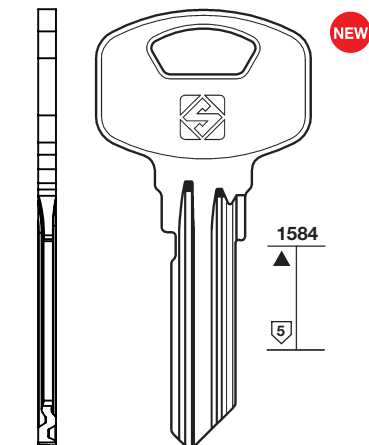

Shoulder milling view

Orig. code: 1109



YA116SM



8 052782 043968

Box of 50

ZEISS IKON*

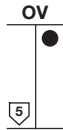
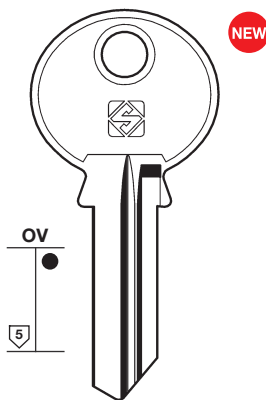

ZE9



8 003736 205178

Box of 100

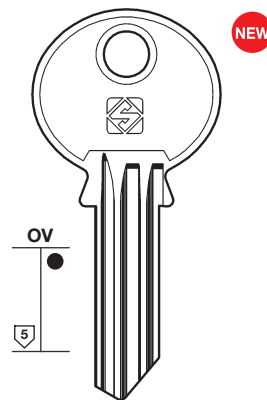

ZE35



8 003736 206915

Box of 100

(* This is a trademark of a third party not affiliated nor linked with Silca S.p.A. or the dormakaba Group. Silca S.p.A. and dormakaba Group do not own any intellectual property right nor have been granted any license with regard to such trademark, which is hereby used only to indicate the intended purpose of Silca's products.



LEGAL NOTES

In compliance with current regulations relating to industrial property, please note that - but for "Silca", "dormakaba", "Kaba", "Ilco" and "Advanced Diagnostics" - the trademarks or trade names mentioned in our document are the exclusive property of third parties not affiliated nor linked with Silca S.p.A. or the dormakaba Group. Silca S.p.A. and dormakaba Group do not own any intellectual property right nor have been granted any license with regard to such trademarks and trade names, which are hereby used only to indicate the intended purpose of Silca's products. / This catalogue is reserved exclusively for professional key cutters who use Silca products. The illustrations and technical data regarding the products in the document are to be considered indicative. Silca reserves the right to alter products designs, dimensions or info to improve the products quality. The contents of this document are fully protected by Copyright and may not be copied or reproduced in any form, without written permission from Silca S.p.A. For any dispute the competent Court is that of Treviso, the applicable law is that of Italy.

RECHTLICHE HINWEISE

In Übereinstimmung mit den geltenden Bestimmungen zum gewerblichen Eigentum weisen wir darauf hin, dass - mit Ausnahme von "Silca", "dormakaba", "Kaba", "Ilco" und "Advanced Diagnostics" - die in unserem Dokument erwähnten Markenzeichen oder Handelsnamen das ausschließliche Eigentum Dritter sind, die weder der Silca S.p.A. noch der dormakaba Gruppe angehören oder mit diesen verbunden sind. Diese Markenzeichen oder Handelsbezeichnungen werden hier nur erwähnt, um auf die bestimmungsgemäße Verwendung der Silca-Produkte hinzuweisen. / Dieser Katalog ist ausschließlich professionellen Schlüsseldiensten vorbehalten, die Silca-Produkte verwenden. Die in diesem Dokument enthaltenen Abbildungen und technischen Daten der Produkte sind als Richtwerte zu betrachten. Silca behält sich vor, etwaige Änderungen, die zur Verbesserung des Produktes beitragen, vorzunehmen. Alle Zeichnungen und Fotos sind Eigentum der Firma Silca. Jede Reproduktion, auch teilweise, ist ohne ausdrückliche Genehmigung der Silca S.p.A. gesetzlich untersagt. Für alle Streitigkeiten ist das Gericht von Treviso zuständig, das geltende Recht ist italienisch.

AVISOS LEGALES

En cumplimiento de la normativa vigente en materia de propiedad industrial, se recuerda que, salvo para "Silca", "dormakaba", "Kaba", "Ilco" y "Advanced Diagnostics", las marcas y los nombres comerciales citados en nuestro documento son propiedad exclusiva de terceras sociedades, no afiliadas ni asociadas con Silca S.p.A. o el Grupo dormakaba. Dichas marcas o denominaciones comerciales se citan aquí solamente para indicar el empleo de destino de los productos Silca. / Este catálogo queda reservado exclusivamente a los duplicadores profesionales, que utilizan los productos Silca. Las ilustraciones y los datos técnicos de los productos contenidos en el documento se han de considerar indicativos. Silca se reserva el derecho, quedando invariables las características principales de los productos, de modificar todo lo que considere necesario y oportuno para mejorar la calidad de sus artículos. Todos los dibujos y fotografías pertenecen a Silca; según determina la Ley, se prohíbe toda reproducción, total o parcial, sin autorización por escrito de Silca S.p.A. Para cualquier litigio el tribunal competente es el de Treviso, la ley vigente es la italiana.

NOTE LEGALI

In ottemperanza alla normativa vigente in materia di proprietà industriale, si ricorda che - fatta eccezione per "Silca", "dormakaba", "Kaba", "Ilco" e "Advanced Diagnostics" - i marchi o i nomi commerciali citati nel nostro documento sono di esclusiva proprietà di terzi, non affiliati né collegati a Silca S.p.A. o al Gruppo dormakaba. Silca S.p.A. e il Gruppo dormakaba non possiedono alcun diritto di proprietà intellettuale né agli stessi è stata concessa alcuna licenza in relazione a detti marchi o denominazioni commerciali, i quali sono qui citati solo per indicare la destinazione d'uso dei prodotti Silca. / Questo catalogo è riservato esclusivamente ai duplicatori professionisti che utilizzano i prodotti Silca. Le illustrazioni e i dati tecnici dei prodotti contenuti nel documento debbono considerarsi indicativi. Silca si riserva il diritto, ferme restando le caratteristiche essenziali dei prodotti, di apportare tutte le modifiche che ritiene necessarie e opportune al fine di migliorare la qualità dei prodotti. Tutti i disegni e le fotografie sono di proprietà di Silca, ogni riproduzione anche parziale, senza autorizzazione scritta di Silca S.p.A. è vietata secondo termini di legge. Per qualsiasi controversia il foro competente è quello di Treviso, la legge vigente è quella italiana.

MENTIONS LÉGALES

Conformément à la législation en vigueur en matière de propriété industrielle, il est rappelé que - à l'exception de "Silca", "dormakaba", "Kaba", "Ilco" et "Advanced Diagnostics" - les marques ou noms commerciaux mentionnés dans notre document sont la propriété exclusive de tiers, non affiliés, ni liés à Silca S.p.A. ou au Groupe dormakaba. Ces marques ou dénominations commerciales ne sont mentionnées ici que pour indiquer la destination des produits Silca. / Ce catalogue est exclusivement réservé aux reproducteurs professionnels qui utilisent les produits Silca. Les illustrations et les données techniques des produits contenues dans le document doivent être considérées comme indicatives. Bien que les caractéristiques essentielles des produits soient invariables, Silca se réserve le droit d'apporter toutes les modifications qu'elle retiendra nécessaires et opportunes afin d'améliorer la qualité de ses produits. Tous les dessins et photos sont propriété Silca et toute reproduction, même partielle, sans l'autorisation écrite préalable de Silca S.p.A. est interdite conformément aux prescriptions légales. Pour tout litige, le tribunal compétent est celui de Trévise, la loi en vigueur est italienne.

NOTÍCIAS LEGAIS

No respeito das normas em vigor relativas à propriedade industrial, lembra-se que - exceptuando "Silca", "dormakaba", "Kaba", "Ilco" e "Advanced Diagnostics" - as marcas ou os nomes comerciais citados no nosso documento são propriedade exclusiva de terceiros, não associados nem ligados à Silca S.p.A. ou ao Grupo dormakaba. Essas marcas ou denominações comerciais são citadas aqui somente para indicar o uso pretendido dos produtos Silca. / Este catálogo é reservado exclusivamente aos profissionais da duplicação que utilizam os produtos Silca. As figuras e as características técnicas dos produtos contidas no documento são facultadas a título indicativo. Mesmo que as características essenciais dos produtos sejam invariáveis, à Silca reserva-se o direito de modificar ser necessário e oportuno os produtos, afim de melhorar a sua qualidade. Todos os desenhos e fotos são propriedade da Silca, e é proibida a sua reprodução mesmo parcial sem a autorização escrita da Silca S.p.A. conforme as prescrições legais. Para qualquer litígio o tribunal competente é o de Treviso, a lei vigente é a italiana.