



Rekord Pro Range

The compact, user-friendly range of key cutting machine



dormakaba Group

Rekord Pro

The compact, user-friendly key cutting machine

Rekord Pro is the compact mechanical key machine for cutting flat cylinder, flat vehicle and cruciform keys.

The perfect solution for businesses cutting 2 to 4 thousand keys per year or around 10 keys per day

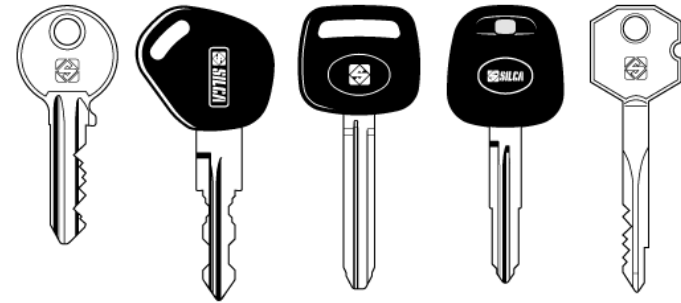

Quick rotation clamps

Rekord Pro uses the quick rotation clamps familiar to Silca Futura users

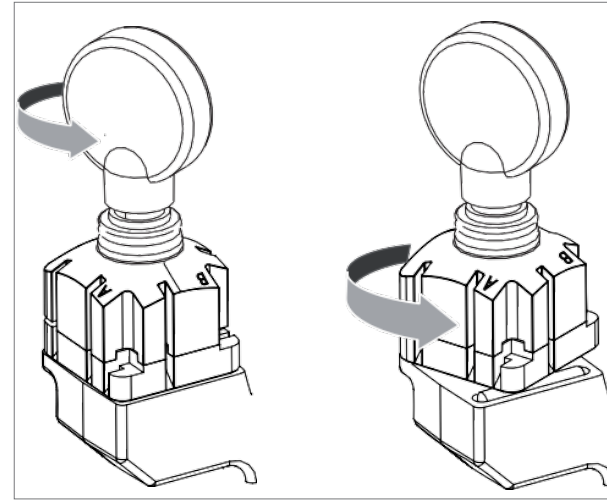

- The clamps can be quickly and smoothly turned without first needing to be removed thanks to the unique, **patented** rotation system.
- Nickel plated, sintered metal composition for strength and durability

Four-sided clamps to cut a wide range of keys

- Large and small flat residential keys, cruciform keys and double-sided automotive keys

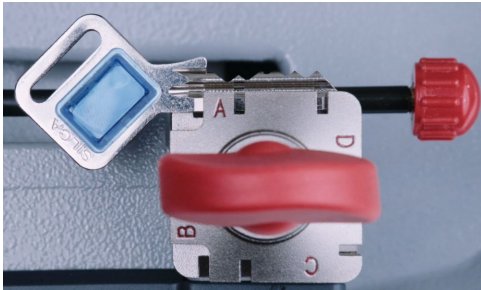

- **Side A:** for keys to be fitted on their rear, keys with double cuts without groove and cruciform keys

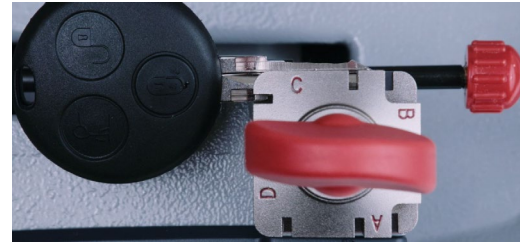

- **Sides C and D:** for keys to be cut on both sides and locked on the groove

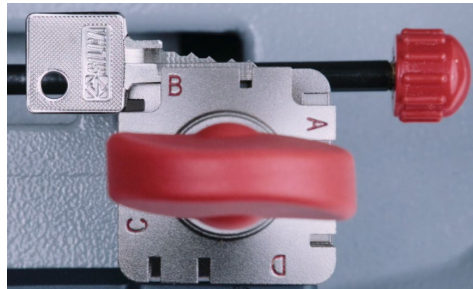

- **Side B:** for keys placed on their rear needing cuts with a depth of less than 3.9mm

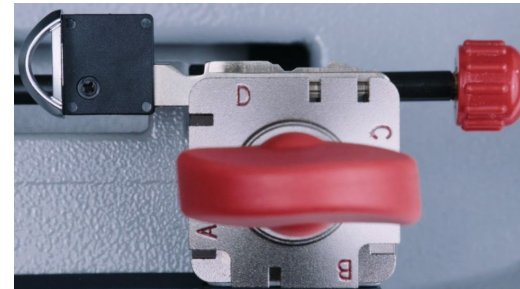

Smooth, precise carriage movements

The easy to operate carriage runs smoothly to ensure a precise, 'first time' duplicate key



- Self-lubricating DU® bushes guarantee smooth carriage movements
- Left hand lever ensures precise carriage shifts without play
- Carriage is released by means of a short lever under the front handle

New long-life TiAlN coated cutter and TYNEX coated de-burring brush

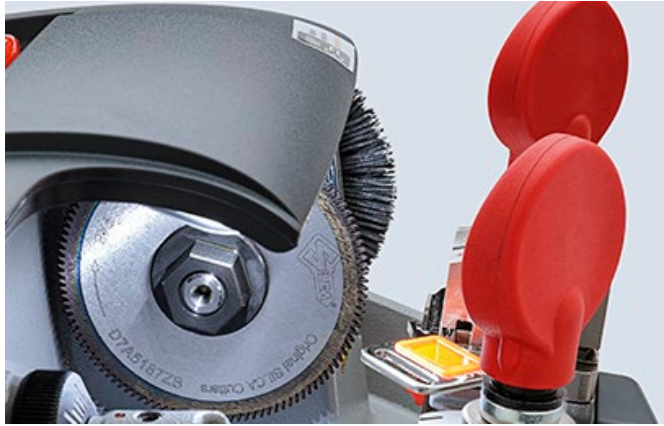

- Titanium aluminium nitride (TiAlN) coating helps maintain a lower temperature during cutting to prolong cutter life
- Cutter made from HSS super-rapid steel
- TYNEX coated de-burring brush ensures uniform abrasion and a perfectly finished key

Ample tool storage areas



- A wide accessories area equipped with an anti-slip mat on the upper part of the machine makes it easy to reach frequently used items
- Below the machine body there is a practical moulded storage compartment for stocking other accessories.

Safety

The on-off switch features a safety cut-out preventing the machine from starting by itself after a power interruption.

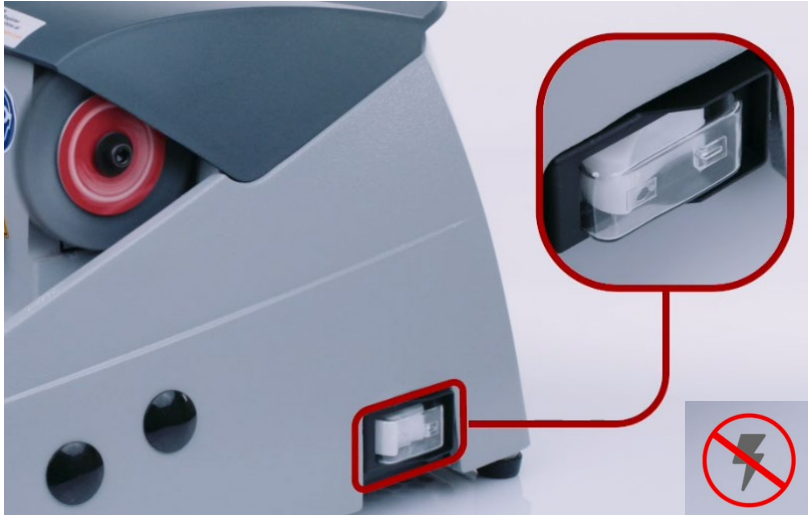

- Rekord Pro switches itself off after a power interruption
- The machine need to be manually restarted to continue the cutting operation

Easy tracer regulation

- Rekord Pro is equipped with a mechanical tracer point with an easy-to-read micrometric adjustment ring for accurate regulation and a precise cutting result.

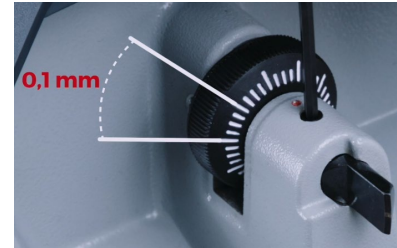

Peace of mind investment

- A dependable key cutting machine with a long record of delivering returns for thousands of businesses worldwide
- 2 year warranty guaranteed by Silca
- Designed and manufactured in conformity with CE standards
- Made in Italy



Rekord Pro has been designed and manufactured in conformity with CE mark European standards.

What's new summary

- Quick rotation clamps
- New titanium aluminium nitride coated cutter (TiAlN) lowers the temperature of the cutter during operation to prolong cutter life
- Updated styling and colours
- Grey body colour like Silca Bravo
- Easier to read tracer point marked in one hundredths



The range



	Pro	Pro S	Pro d-12	Pro AY
Quick rotation clamps	✓	✓	✓	✗
TiAlN coated cutter	✓	✓	✓	✗
Automatic cutter start	✗	✓	✓	✗
Cuts flat residential, flat automotive & cruciform keys	✓	✓	✓	✗
Cuts Assa d-12, CLIQ & DP keys	✗	✗	✓	✗
Cuts Abloy-type keys (AY1, AY2)	✗	✗	✗	✓

Rekord Pro S

- Cuts flat residential, flat automotive & cruciform keys
- Automatic cutter start
- Quick rotation clamps
- Long life TiAlN cutter

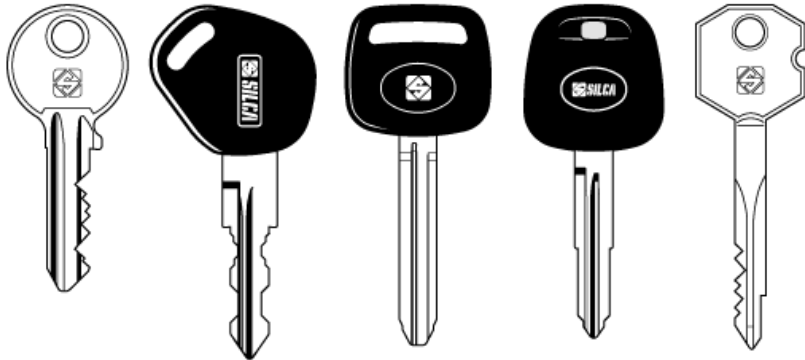

Rekord Pro

Rekord Pro AY

- Cuts Abloy-type keys (AY1, AY2)
- Cuts by code

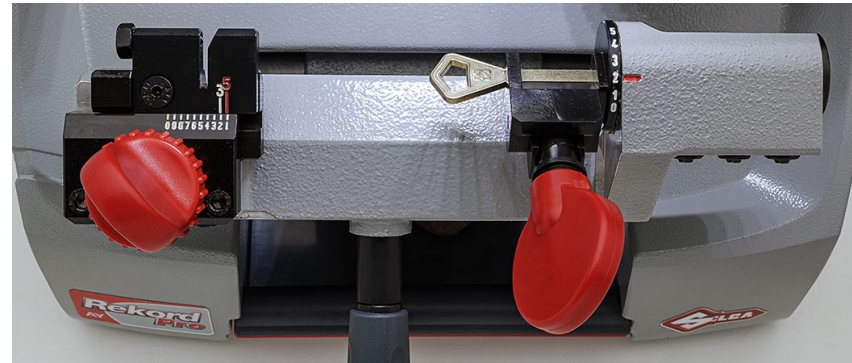
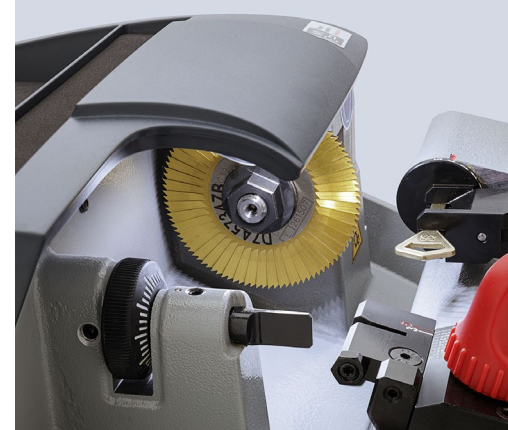
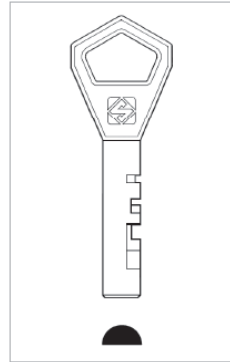

Rekord Pro d-12

- Cuts flat residential, flat automotive & cruciform keys
- Cuts Assa d-12, CLIQ & DP keys
- Automatic cutter start
- Quick rotation clamps
- Long life TiAlN cutter

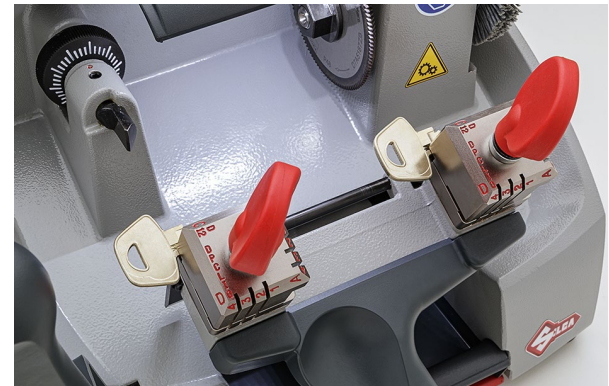
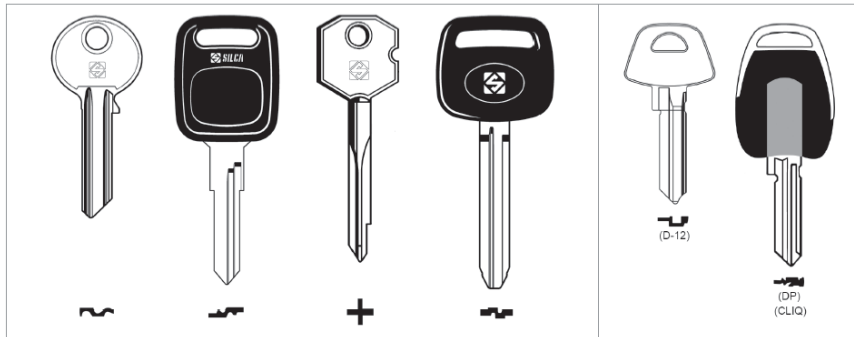

Technical Data

Power supply	230V – 50/60Hz. Absorbed power 440W 2A
Cutter motor	Single phase 230V 56/60Hz
Prismatic cutter	HSS Super rapid steel titanium aluminium nitride (TiAlN) coated
Cutter speed	1350/1620 rpm
Clamp	Rotating 4-sided
Movements	By gear on rectified carriage
Carriage Runs	43mm (max. length of cuts)
Dimensions	width: 330mm, depth: 430mm, height 270mm
Weight	19 Kg

In compliance with current regulations relating to industrial property, we hereby state that the trade-marks or trade names mentioned in this document are the exclusive property of authorized manufacturers of locks and users. Said trade-marks or trade names are nominated only for the purposes of information so that any lock for which our keys are made can be rapidly identified. This document is reserved exclusively for professional key cutters who use Silca products. / All information and illustrations in this document are for guidance only. Silca reserves the right to alter products designs, dimensions or info to improve the products quality. The contents of this document are fully protected by Copyright and may not be copied or reproduced in any form, without written permission from Silca S.p.A. Any controversy shall be settled by the Courts of Justice where the company has its headquarters, with express exclusion of any other court.

