



OPTIKA

Operating manual

D433712XA

vers. 7.0

EN



© 2008 SILCA S.p.A - Vittorio Veneto

This manual has been drawn up by SILCA S.p.A.

All rights reserved. No part of this publication may be reproduced or used in any form or by any means (photocopying, microfilm or other) without the written permission of SILCA S.p.A.

Edition: June 2021

Printed in Vittorio Veneto
by SILCA S.p.A.
via Podgora, 20 (Z.I.)
31029 VITTORIO VENETO (TV) - Italy

INDEX

GUIDE TO CONSULTATION	1
GENERAL	2
1 TRANSPORT	3
1.1 Packing	3
1.2 Transport	3
1.3 Unpacking the machine	3
1.4 Handling the machine	3
1.5 Checking for damage	3
2 ACCESSORIES PROVIDED	4
3 DESCRIPTION OF DEVICE	5
3.1 Main characteristics	6
3.2 Technical Data	6
3.3 Main operating parts	7
4 DEVICE INSTALLATION AND PREPARATION	8
4.1 Separate Parts	8
4.2 Connection to external supply points	8
4.3 Environmental conditions	8
4.4 Positioning	9
4.5 Description of work station	9
5 USING OPTIKA	10
5.1 Optika's software update	10
5.2 Interface flow on the machine	10
5.3 Initial operations	10
5.4 Fitting or removing the key into or from the clamp	11
5.4.1 Key insertion	12
5.4.2 Bit key insertion with lighth shade device	12
5.4.3 Key removal	12
5.4.4 Fitting of SHOULDER STOP key with adapter (code D737017ZB) ...	14
6 INSTRUCTIONS FOR USE	15
6.1 Key search	15
6.1.1 KEY POSITIONING	16
6.1.2 STEP 1: VIEWING THE CUTS	17
6.1.3 STEP 2: VIEWING THE PROFILE	18
6.1.4 SPECIAL CASES	21
6.1.5 SUPPLEMENTARY SEARCH DATA	23
6.1.6 POSSIBLE ERRORS IN THE "KEY SEARCH" FUNCTION	25
6.2 Key Matching	26
6.2.1 MATCHING FROM "NEW READING"	27
6.2.2 MATCHING FROM "LAST READING"	35
6.2.3 POSSIBLE ERRORS DURING "CUT MATCHING"	35
6.3 Key copy	37
6.3.1 Transmission from main menu	37
6.3.2 Transmission at the end of a search	38
6.3.3 Possible errors during communication with the key-cutting machine ..	38
6.4 Options	39

6.4.1	MACHINE DATA	39
6.4.2	LANGUAGE	39
6.4.3	USER PROFILES	40
6.4.4	KEYS IN STOCK	41
6.4.5	SEARCH TYPE	41
6.4.6	MATCHING TYPE	41
6.4.7	TEST HARDWARE	42
6.4.7.1	CHECK ADJUSTMENT	42
6.4.7.2	CHECK PROFILE AREA	43
6.4.7.3	CHECK CUTS AREA	44
6.4.7.4	TELECAMERA and LED	44
6.4.7.5	DISPLAY	44
6.4.7.6	KEYBOARD	44
6.4.8	UPDATING OPTIKA INTERNAL PROGRAM	45
6.4.9	SERVICE MENU	45
7	MAINTENANCE	46
7.1	Clamp replacement	46
7.2	Clamp cleaning	47
7.3	Check machine gauging	47
7.4	Knob replacement (ESC/ENTER)	47
8	DISPOSING OF MACHINE	48
9	AFTER-SALES SERVICE	49
9.1	How to request service	49
	Appendix 1 - ELECTRIC DIAGRAMS	I -IV

GUIDE TO CONSULTATION

This manual has been produced to serve as a guide for users of the OPTIKA device. Read it carefully; it is essential if you wish to operate your machine safely and efficiently.

Consultation

The contents of the manual are divided into sections relating to:

Transport and handling	1
Machine description and safety	2-3-4
Proper use	5-6
Maintenance	7

Technical terms

Common technical terms are used in this manual. To assist those with little experience of keys, below is an illustration of the terms most frequently used:

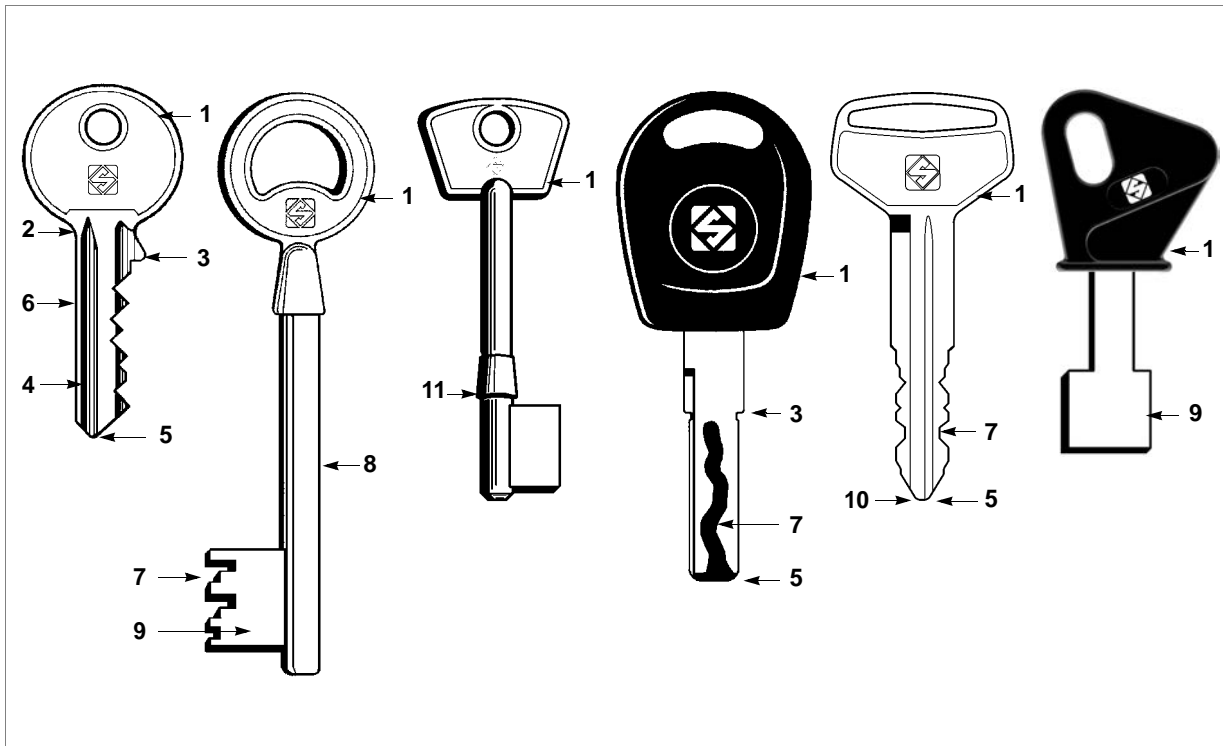

Fig. 1

- 1) Head
- 2) Neck
- 3) Shoulder
- 4) Blade
- 5) Tip
- 6) Back
- 7) Cutting
- 8) Stem
- 9) Bit
- 10) Tip stop
- 11) Shoulder stop

GENERAL

The OPTIKA device has been designed according to the specifications of the Electromagnetic Compatibility Directives.

From the design stage risks for the operator have been eliminated in all areas: transport, reading, regulation and maintenance.

The material used in the manufacture of this device and components employed during its use are not dangerous and render OPTIKA compliant with directives.

Use

Instructions for installation and use of the OPTIKA device are those laid down by the manufacturer.

If the device is used differently or for purposes different from those described in this manual, the customer will forego any rights he may have over Silca S.p.A. Furthermore, unforeseen danger to the operator or any third parties may arise from incorrect use of the machine.

Negligence in the use of the machine or failure on the part of the operator to observe the instructions given in this manual are not covered by the guarantee and the manufacturer declines all responsibility in such cases.

It is therefore indispensable to read the operating manual carefully in order to make the best use of the device and benefit from its potential.

Instructions manual

The instructions manual provided with the machine is essential to its proper use and to carry out the necessary maintenance.

We therefore recommend protecting the manual from damage in a safe sheltered place, easily to hand for quick consultation.

Further risks

There are no further risks arising from the use of the OPTIKA device.

Protection and safety precautions for the operator

The OPTIKA device is built entirely to the Machine Directive. The operations for which it has been designed are easily carried out at no risk to the operator.

The adoption of general safety precautions and observance of the instructions provided by the manufacturer in this manual eliminate all human error, unless deliberate.

The OPTIKA device is designed with features which make it completely safe in all its parts.

- **Power supply**

The device is powered by electricity through a 15 Vdc universal power supply unit, provided.

Attention: as the device has no master switch, it remains live when connected.

ATTENTION: if the power supply must be cut off, wait at least 10 seconds before re-connecting Optika to the mains.

- **Maintenance**

The operations to regulate, service, repair and clean the machine have been devised in the simplest and safest way possible. There is no danger of removable parts being replaced wrongly or unsafely.

- **Software Update**

The machine can be updated by RS232 connection to a personal computer or by USB device prepared with the aid of the Key Reader Program (provided with the machine) or Silca Key Programs.

- **Machine identification**

The OPTIKA device is provided with an identification label that shows the serial number (fig. 2).

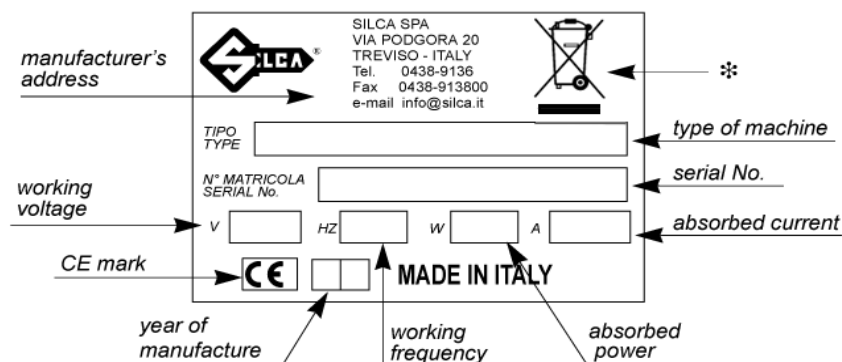

Fig. 2

(*) see ch.8 DISPOSAL, page 48.

1 TRANSPORT

The OPTIKA device is easily transported and is not dangerous to handle. The device can be carried by one person, even when packed.

1.1 Packing

The OPTIKA device is packed in a strong cardboard box, the dimensions of which are shown in fig. 3 sufficiently robust to be used for storing the machine for long periods.

Inside the packing box the device is fully protected by expanded polyethylene shells.

The shells and cardboard box ensure safe transportation and protect the machine and all its parts.

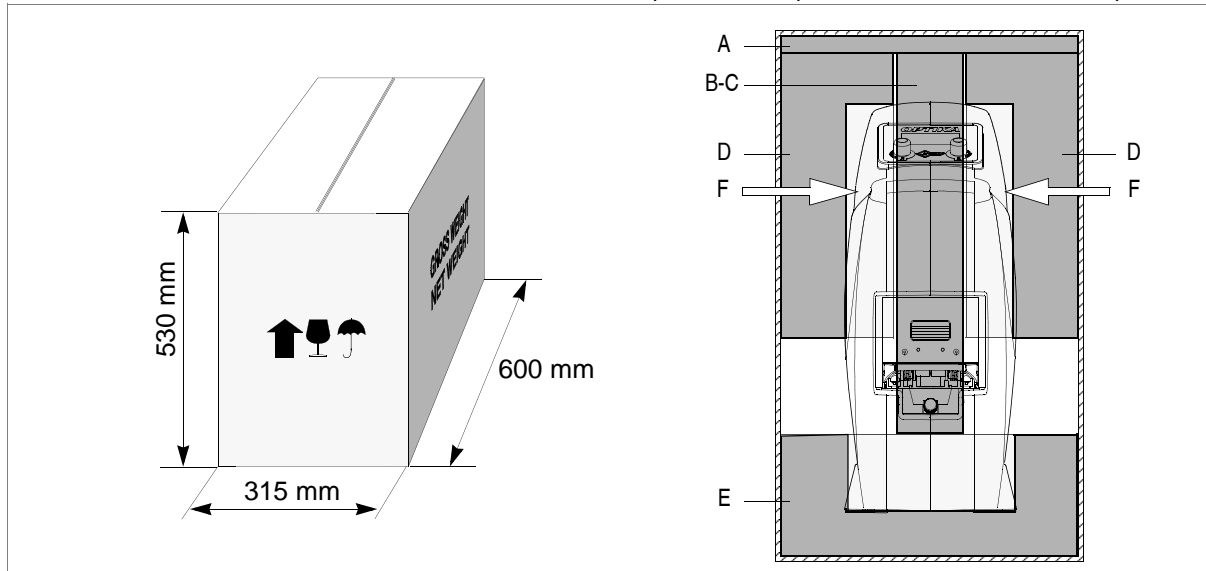

Fig. 3

1.2 Transport

To avoid damaging the OPTIKA it must always be transported in its packing case. This will prevent sudden movements or rough handling from damaging the machine, persons or things.

1.3 Unpacking the machine

ATTENTION: if the device comes from a cold environment, to prevent the effect of condensation on the devices lenses it is necessary to wait a few hours before use (unpacking).

To remove the machine from the packing box:

- 1) Open the box without damaging it so that it may be used again (removals, dispatch to manufacturers for repairs or servicing).
- 2) Remove the upper protective panel (A) and the two blocks (B) and (C).
- 3) Check the contents of the box, which should comprise:
 - 1 OPTIKA device enclosed in protective shells
 - 1 power supply unit
 - 1 accessories kit
 - 1 set of documents, including: operating manual, spare parts list and guarantee
- 4) Take out the 2 side protection shells (D) by pulling them upwards.
- 5) Grip the two top cavities (F) and lift the machine.

1.4 Handling the machine

When the device has been unpacked, place it directly on its workbench.

This operation can be carried out by one person, firmly holding the device gripping the two top cavities (F) or the base.







ATTENTION: never lift the device by holding the clamp opening lever (B) (fig. 7, page 7).

1.5 Checking for damage

OPTIKA is solid and compact and will not normally damage if transport, unpacking and installation have all been carried out according to the instructions in this manual. However, it is always advisable to check that the machine has not suffered any damage.

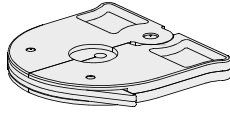
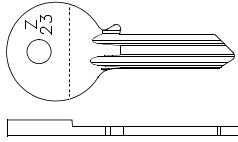
2 ACCESSORIES PROVIDED

The tools provided by Silca are those necessary and sufficient for carrying out the operations involved.

 <p>Power supply unit</p>	 <p>Serial cable</p>
 <p>Power cable</p>	 <p>Light shade device for bit and pump keys</p>
 <p>Setting template Z23</p>	 <p>CD rom "Key Reader Program"</p>
 <p><i>clamp cleaning brush</i></p>  <p><i>key cleaning brush</i></p> <p>Cleaning tools</p>	

3 DESCRIPTION OF DEVICE

OPTIKA is a key-reading device that incorporates high quality performance and precision. Optika reads a profile and recognises most flat, bit and double bit keys, subject to their being included in the Silca database.

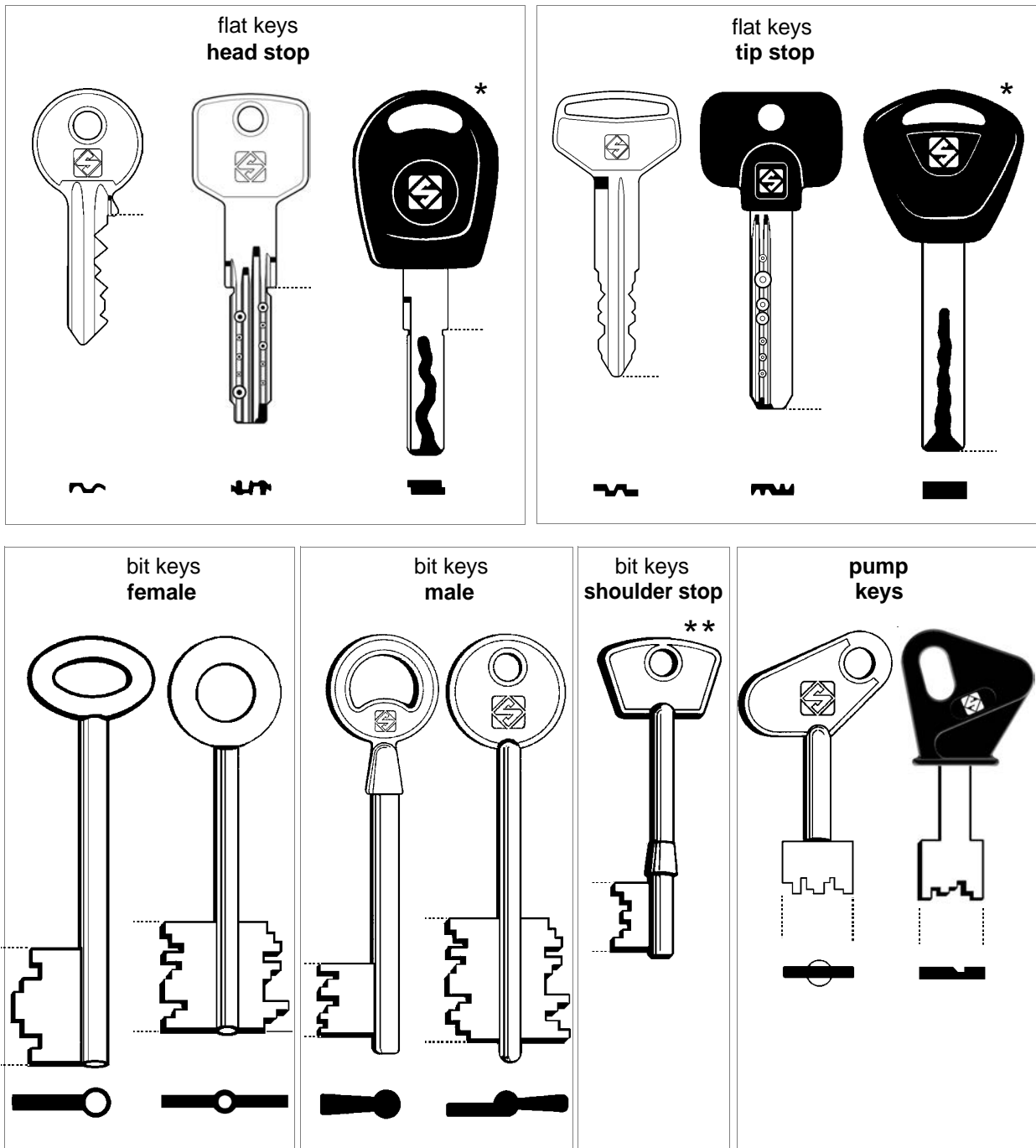

(*) With a cut key the profile is read properly and recognized only if the cuts have not touched or altered the part used for recognition. Example (fig. 4):

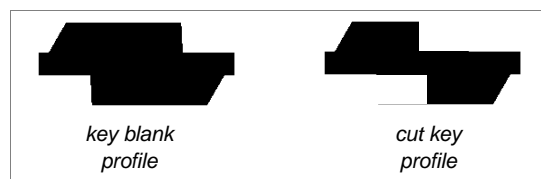

Fig. 4

(**) Shoulder stop keys are managed only in KEY MATCHING mode and need an optional adapter.

3.1 Main characteristics

- KEY CLAMP

The standard clamp is universal and takes all keys provided by Silca.

The clamp is opened and closed by means of a lever (B) (fig. 7, page 7).

The clamp has a rotation system that facilitates alignment of the keys. To rotate the key simply move the lever to one side (B).

The clamp is easily removed to facilitate cleaning and maintenance operations) (ch. 7.1, page 46).

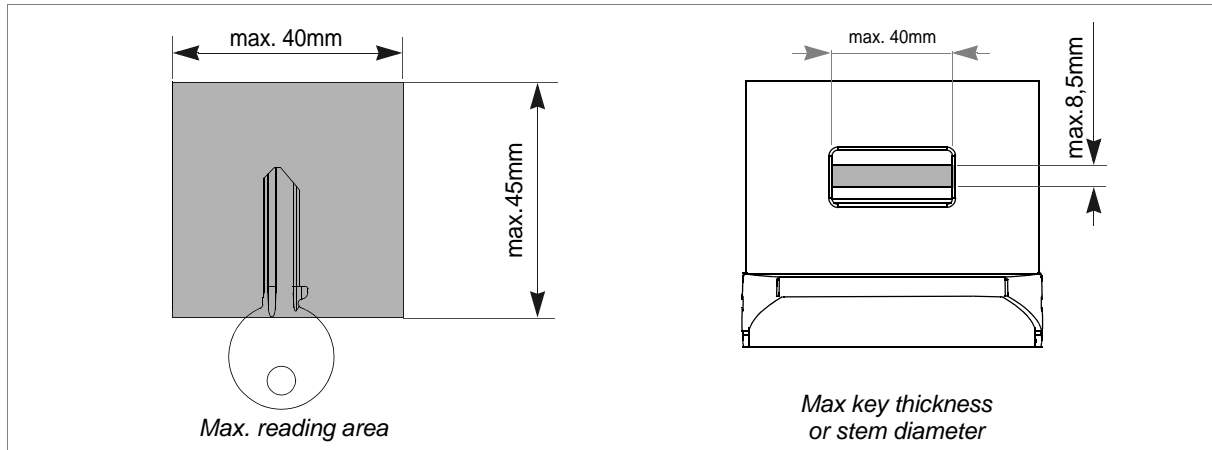

Fig. 5

- DISPLAY

The display located on the top of the device comprises 5 lines of 20 characters each.

- CONTROLS

The pointer is moved by rotating the two knobs clockwise or anticlockwise.

- Press ENTER to confirm your choice or the operation in progress.
- Press ESC to go back or abandon the operation in progress.

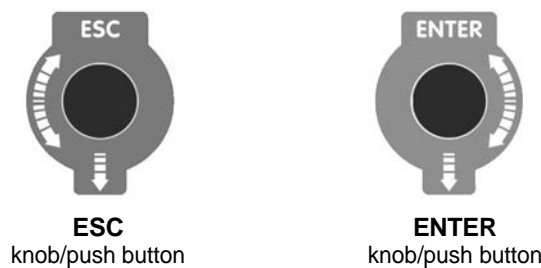

Fig. 6

- STAND BY

When the device is connected and switched on it remains on, as it does not have a master switch. If it is not used within approximately 5 minutes of switching on, it automatically goes onto stand by, the display goes black and key illumination goes off. This also happens when the device is left in order to carry out a search for a key. In any case, just press or rotate one of the 2 knobs to reinstate normal operation.

Note: the Stand By function has been adopted to safeguard duration of the display.

- DATABASE

The database on the machine is a summary of all the profiles for keys produced by Silca and recognisable by the device (not the full Silca range).

3.2 Technical Data

DIMENSIONS: width: 190 mm - depth: 480 mm - height: 400 mm

NET WEIGHT: 9Kg.

3.3 Main operating parts



Fig. 7

OPTIKA device

- A - Key clamp
- B - Clamp-opening lever
- C - Display
- D - ENTER Knob/push button
- E - ESC Knob/push button
- F - Illuminators
- G - Power supply socket
- H - Serial receptacle
- I - USB receptacle (slave)
- L - Double USB receptacle (master)
- M - Power supply unit

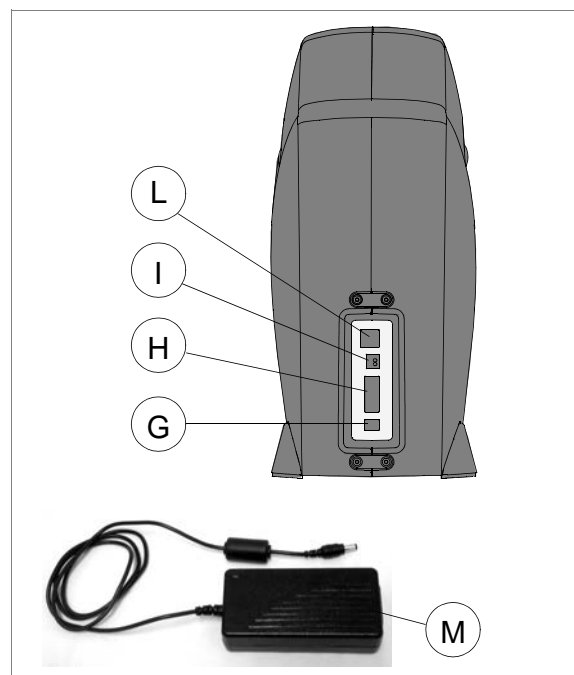

Fig. 8

4 DEVICE INSTALLATION AND PREPARATION

The device can be installed by the purchaser and does not require any special skills. However, some checks and preparation for use have to be carried out by the operator.

4.1 Separate Parts

Power supply cable and power supply unit

Connect OPTIKA to the power supply unit (M) and connect to the power source by means of the power supply cable (fig. 9).

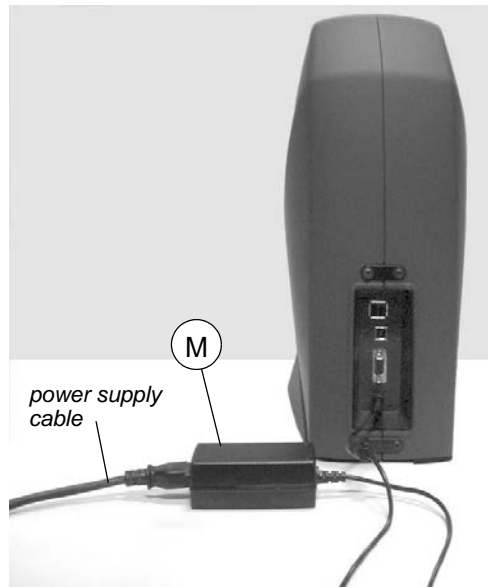

Fig. 9

4.2 Connection to external supply points

For the protection of the device and the operator's safety it is extremely important to ensure that it is connected to the power mains with the right voltage and by means of a properly earthed differential switch.

4.3 Environmental conditions

The OPTIKA device uses a series of instruments whose operation could be significantly affected by the environment in which they work. The most suitable conditions for the device are:

- Temperature between +10° C e +40° C
- Relative humidity 60% (Max) (without condensation)
- It is in any case advisable to avoid excessively damp or badly ventilated areas.

Note: like any device using lenses for reading images, whenever the temperature goes suddenly from low (0°C or lower) to high (20-25°C), the lenses may cloud and condensation form. In such cases the device must be placed in an area with constant temperature of 20°C if possible, until the condensation on the lenses evaporates and the device can operate in normal conditions.

4.4 Positioning

Place the OPTIKA device on the mat provided, on a solid horizontal worktop suitable for the weight of the machine (9 Kg).

ATTENTION: position OPTIKA device away from sources of light (spotlights, lamps, etc....).

ATTENTION: it is advisable to place the device in a clean dust-free environment.

To facilitate use and maintenance, leave a clearance of at least 200 mm round the device (fig. 10).

Check that the machine is firmly placed and steady; its horizontal position avoids obstacles during reading.

ATTENTION: make sure the device (power supply unit) voltage is suitable for your power supply, which should be earthed and provided with a differential switch.



Fig. 10

4.5 Description of work station

The device needs only one operator, who has the following controls at his/her disposal (fig. 7 a pag. 7):

- display (C);
- knob/push buttons (D) (E);
- clamp (A).

5 USING OPTIKA

Note: the device may be used in Stand Alone mode or with the KEY READER PROGRAM provided with the machine.

The KRP program completes the machine functions by facilitating operations that would be difficult to manage through the device keypad and display.

Such operations are:

- Assigning hook positions to customer key blank lists
- Preparing and running lists (filters) for own key stores
- Searching for profiles with more sophisticated filters (e.g. setting exact stem length...)
- Enlarging views of comparisons of profiles read with those in the Silca database.
- Updating Optika internal program.

5.1 Optika's software update

To update Optika's software, refer to instructions in chapter ch. 6.4.8, page 45.

5.2 Interface flow on the machine

Optika comes with:

- a graphics display of 5 lines and 20 characters
- 2 knobs/push buttons that move the display pointer up/down, right/left; functions are confirmed by pressing the knobs.



Fig. 11

5.3 Initial operations

When the device is turned on, the display will show the following message:

```

OPTIKA
Ver.Sw: 1.00.001
Ver.DB: 1.00
  
```

Note: only on initial start, the display will show the following message:

```

Italian
*English
French
German
Spanish
  
```

- Turn the ENTER knob clockwise and/or anticlockwise to scroll and select the various languages.
- Press the ENTER knob to confirm the selected language.
- After 20 seconds the display will show the device SW version and a message to wait for data loading to be completed.

- After a further 10 seconds the display will show the symbols for the functions involved:

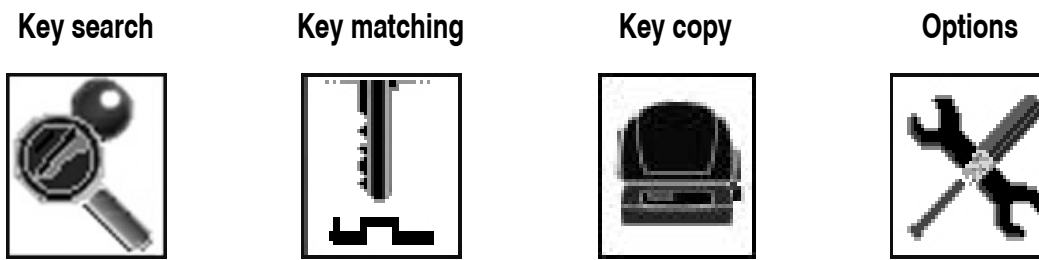

The display shows the first function of 'Key search' already selected.

- To enter one of the 4 functions in the menu, just turn the ENTER push button/knob to select the function (illuminated symbol and description) then press the ENTER push button.
- Press the ESC push button to leave the function.

5.4 Fitting or removing the key into or from the clamp

WARNINGS

To read the key and use the machine properly remember that:

- To avoid condensations on the devices lenses, it is recommended to not move the device from a cold environment to a warm environment. If this is the case, it is recommended to wait a few hours before use of the device.
- The key must be carefully cleaned. Any residue on the profile, such as grease, deposits, filaments, dust or whatever, may cause errors (use the brush provided).
- The key must be of the required type (see ch.3).
- The key must not be all black (plastic or surface treatment).
- For bit, double bit and pump keys the light shade adapter must be fitted.
- For bit keys with shoulder stop use the special adapter for reading cuts and do not use the light shield adapter, as profile reading and searching for this type of key are not managed.
- The key must be intact. If it is broken it must have a regular profile.
- The key must not be bent or twisted and the part to be read must be free of dents (especially bumps in the material on the tip, or burrs).
- The key must be fitted into the centre of the clamp and not sloping (fig. 17). Make sure it is not facing too far to the right or left (fig. 18).
- If the key is one of a bunch, it can still be read, as long as the clamp functions and the key position are not affected.
- Only keys can be fitted into the Optika device clamp (for maximum dimensions see fig. 5, page 6).

Fitting

Note: make sure the clamp (which can be opened and rotated) is well centred and not turned fully left or right (fig. 12).

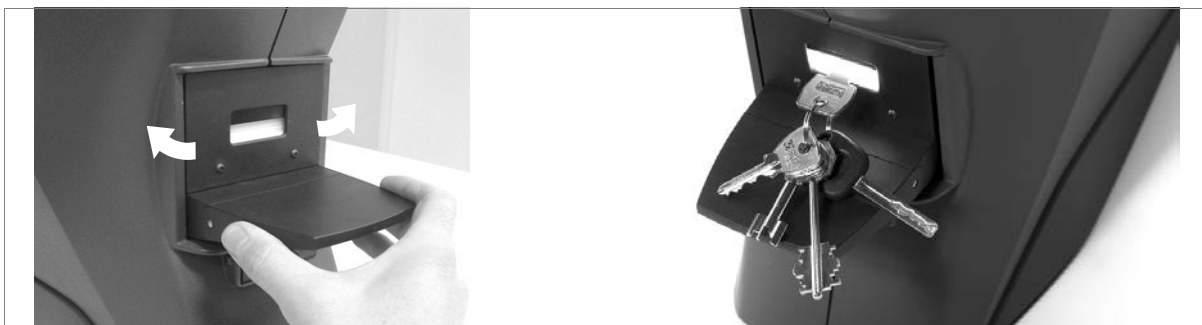

Fig. 12

5.4.1 Key insertion

- 1) Take hold of the key head with one hand and with the other lower the clamp opening lever (fig. 13).
- 2) With the clamp open fit the key, taking care that:
 - the key is well centred on the clamp (not too far to the right or left) (fig. 18).
 - it is aligned as well as possible (not turned right or left) (fig. 16).
- 3) For bit keys make sure the key head is aligned horizontally (see fig. 23, page 18).



Fig. 13

5.4.2 Bit key insertion with light shade device

Opening the light shade device:

Hold the side of the adapter and lift the closing tab.

Closing the light shade device:

Insert the key to be dimmed and close the adapter by lowering the lever until it clicks into place.

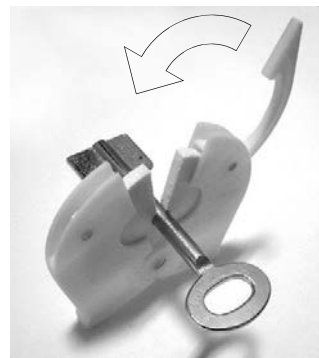

Fig. 14 - light shade device

5.4.3 Key removal

Removing

Note: the key must be removed only when the clamp is open. Removing it with the clamp closed will damage the illuminators and the key plate (glass).

- 1) Take hold of the key head with one hand and with the other lower the clamp opening lever (fig. 15).
- 2) With the clamp open, lift the key in it so that the glass plate is not scratched and remove the key.
- 3) Release the clamp opening lever.



Fig. 15

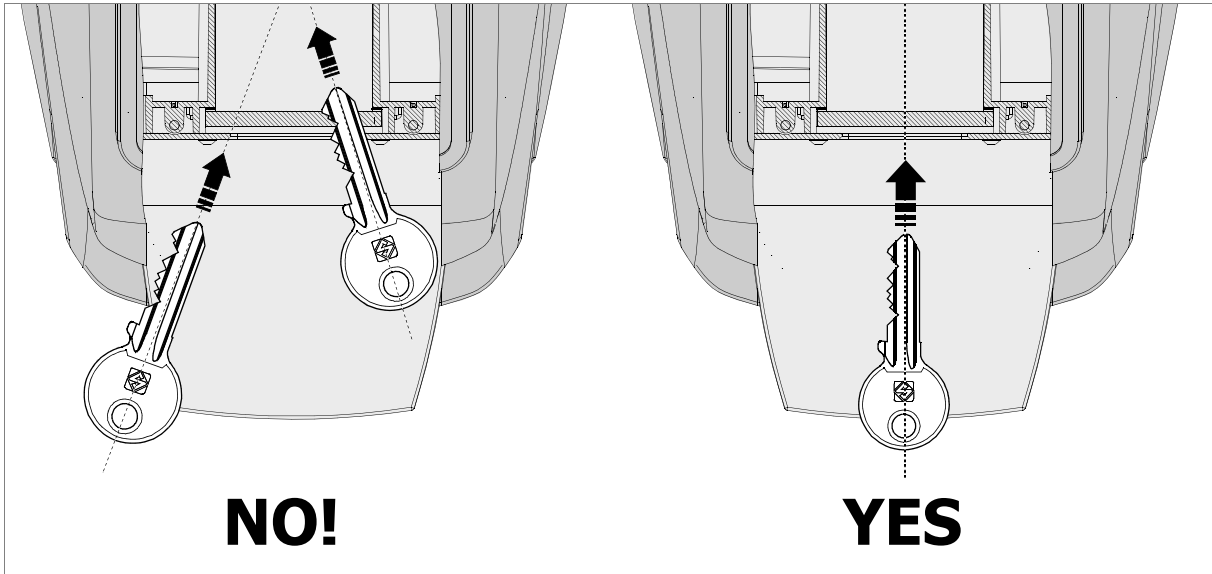

Fig. 16

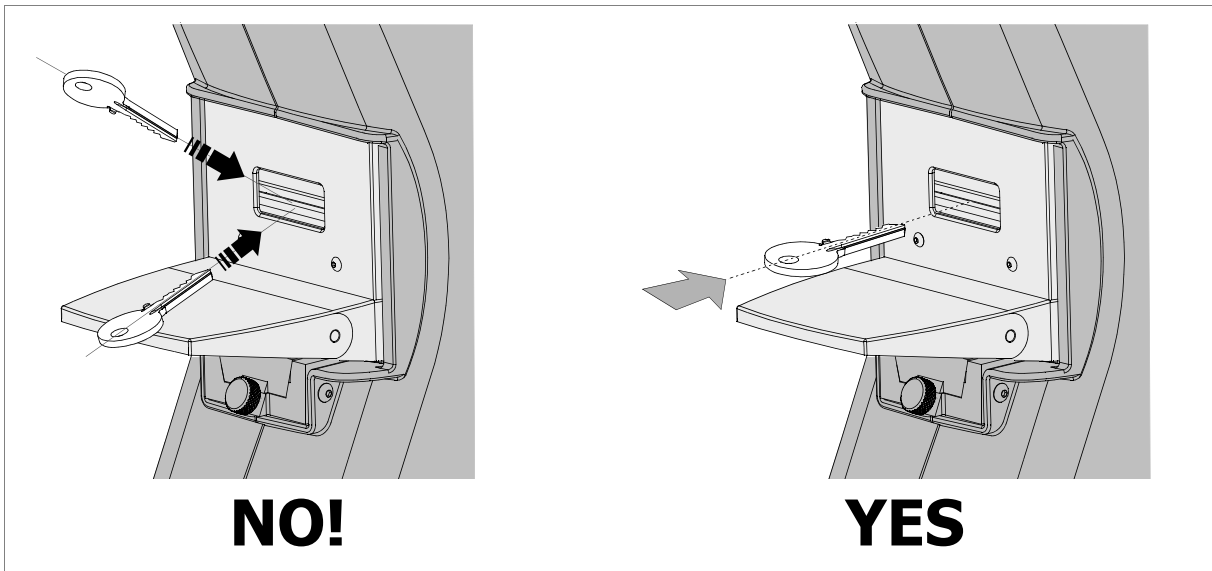

Fig. 17

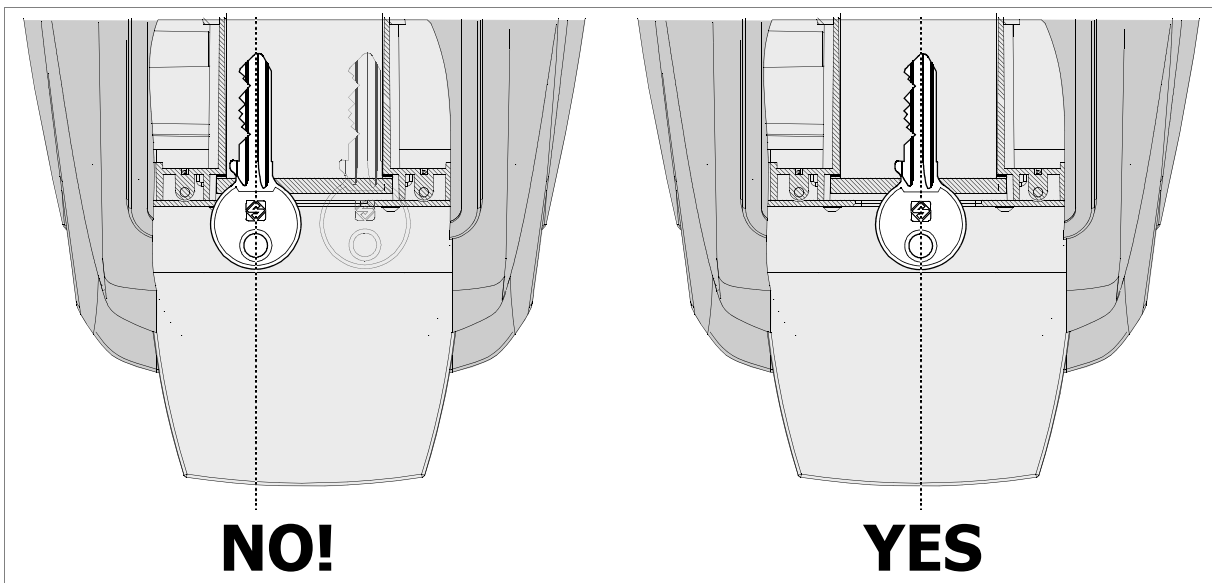

Fig. 18

5.4.4 Fitting of SHOULDER STOP key with adapter (code D737017ZB)

- 1) Lower the lever (B) on the clamp and fit the adapter all the way up against the illuminators (fig. 20).
- 2) With the lever down fit the key with its stop up against the stop on the adapter (fig. 21).

ATTENTION: the bit must be facing left.

- 3) Release the lever and proceed with the operation in question.

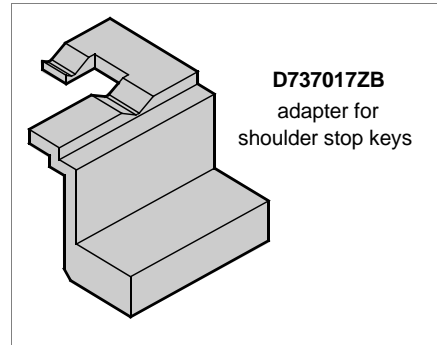

Fig. 19

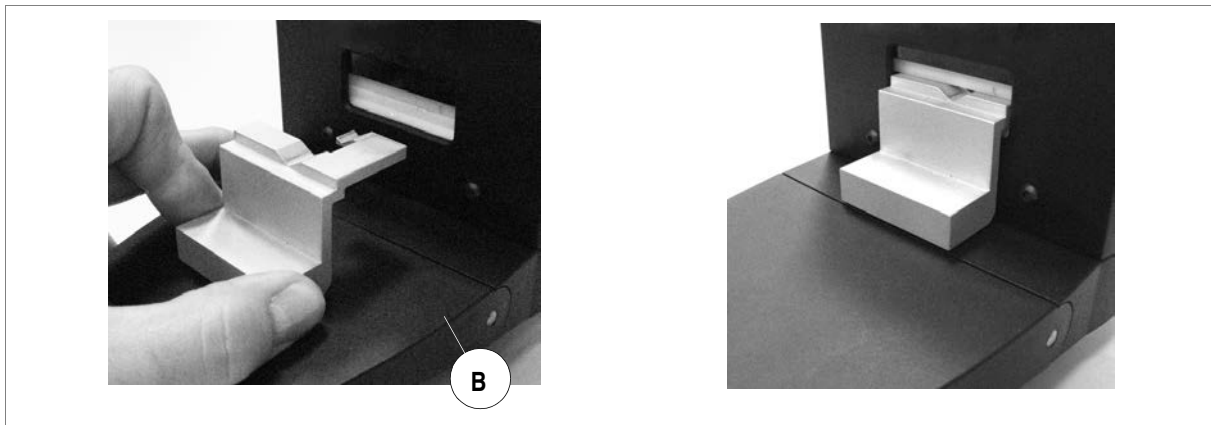

Fig. 20

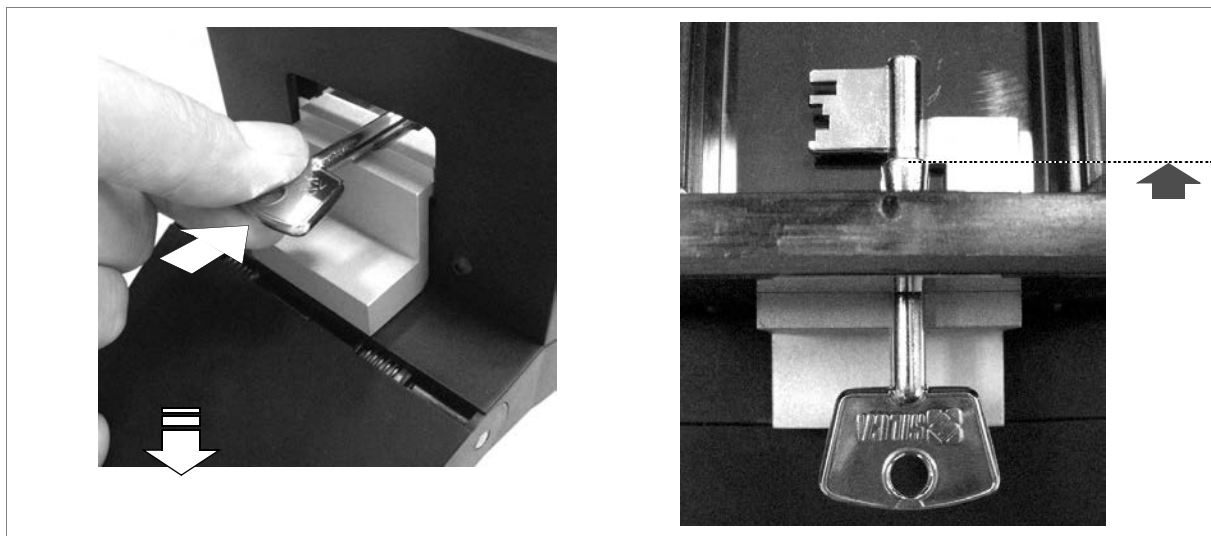

Fig. 21

6 INSTRUCTIONS FOR USE

The main functions that can be carried out on the OPTIKA device are:

- KEY SEARCH
- KEY MATCHING
- KEY COPY
- OPTIONS

6.1 Key search



- This function is used to detect/check the profile of an original key and find the corresponding reference if it is included in the Silca database.
- This function is used to detect the profile of a spare key (not Silca) when the Silca comparatives are not known, by finding the corresponding reference (if in the Silca database).
- This function also reads cuts that can be used in the "Key Comparison" function.

Press ENTER; the display will show:

```

Select key type:
Flat - Shoulder stop
Flat - Tip stop
Bit male
Bit female
Pump
  
```

Turn the ENTER knob to select the type of key to be searched for (the description will be highlighted by a yellow strip over black characters).

Press the ENTER button and the display will show the message (the same for all types of keys):

Flat keys

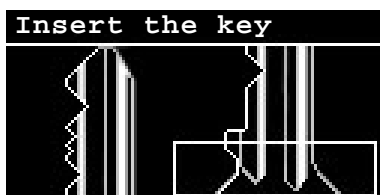

Bit keys

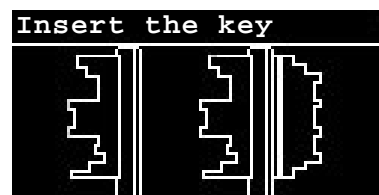

6.1.1 KEY POSITIONING

- Flat - Shoulder stop
- Flat - Tip stop
- Bit male (with light shade device)
- Bit female (with light shade device)
- Pump (with light shade device)

ATTENTION: the key must be carefully cleaned. Any residue on the profile, such as grease, deposits, filaments, dust or whatever, may cause errors (use the brush provided).

Flat keys

Bit keys

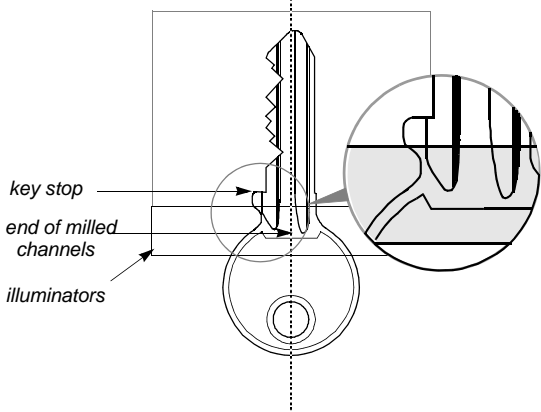
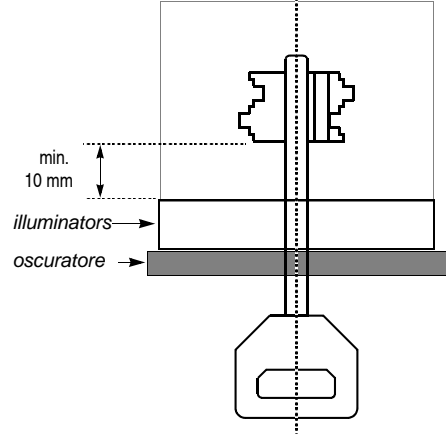
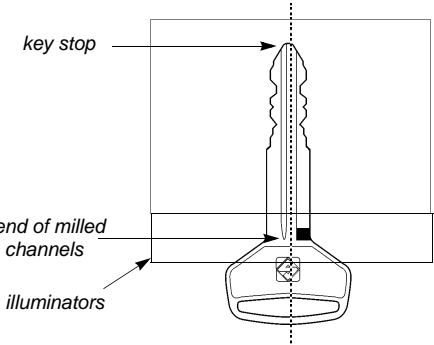
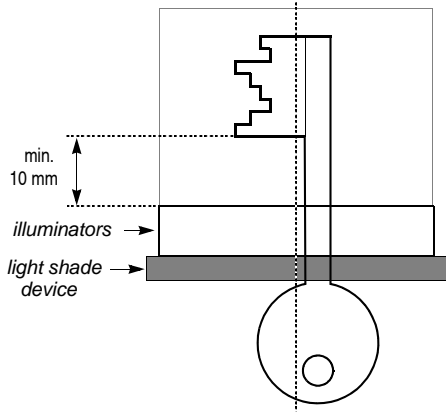
<p>Example: FLAT - SHOULDER STOP</p>  <ul style="list-style-type: none"> - The key stop must be past the illuminators. - The end of milled channels must be beneath the illuminators. - The bitting of single side keys must face left. 	<p>Example: DOUBLE BIT KEY</p>  <ul style="list-style-type: none"> - The bit must go past the illuminators. - A minimum of 10 mm. of stem must be inserted. - The key stem must be entirely surrounded by the light shade device.
<p>Example: FLAT - TIP STOP</p>  <ul style="list-style-type: none"> - The end of milled channels must be beneath the illuminators. - The bitting of single side keys must face left. 	<p>Example: BIT KEY</p>  <ul style="list-style-type: none"> - The bit must go past the illuminators. - A minimum of 10 mm. of stem must be inserted. - The key stem must be entirely surrounded by the light shade device.

Pump keys

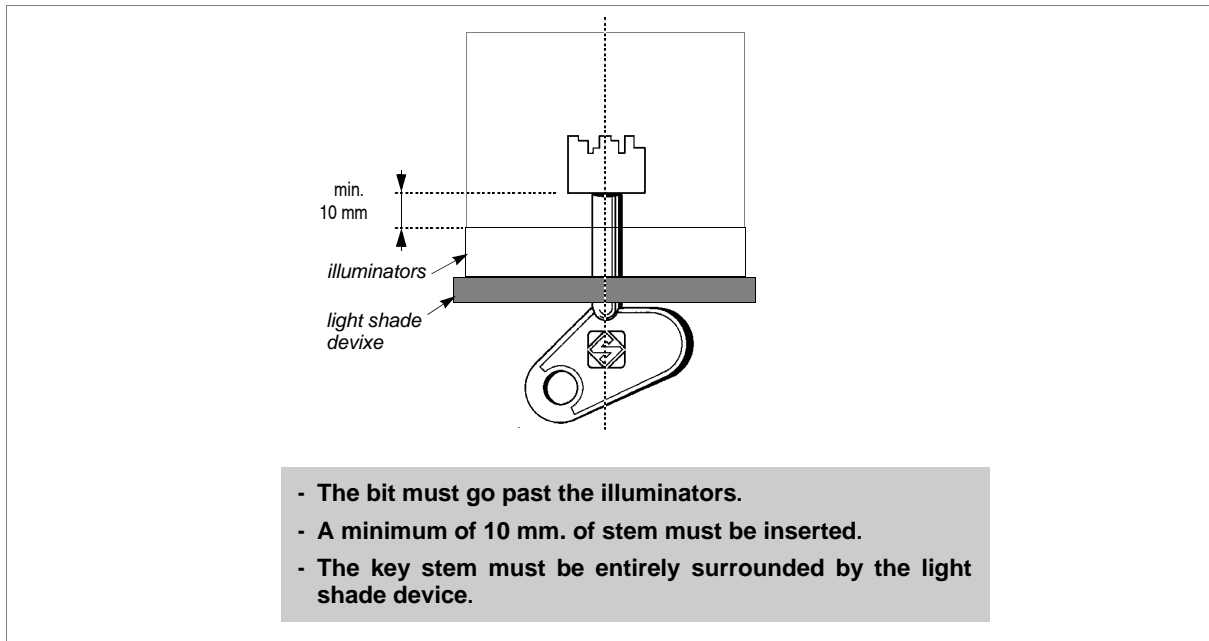

After inserting the key involved, the display will show a plan view of the key (turn the ENTER knob to change the view from horizontal to vertical and vice versa). Make sure the stop detector line/pointer (hatched) is the right position and that the top key alignment bar is as fine as possible (fig. 22).

6.1.2 STEP 1: VIEWING THE CUTS

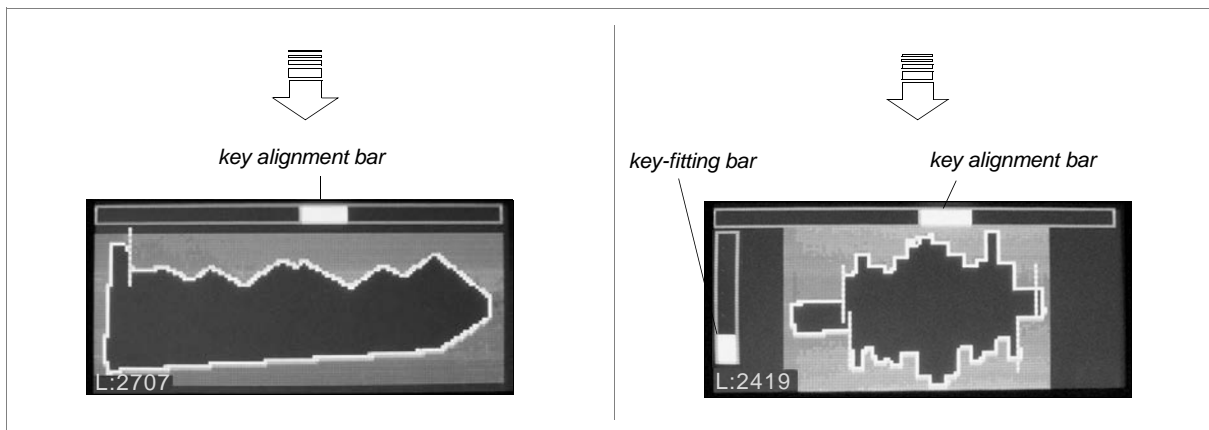

- If the key stop cannot be seen in the flat key view on the display, the pointer will flash and be approximately in the centre of the display. Just push the key head slightly so that the key advances well into the clamp.
- If in the view of the key on the display (male and female bit) the left-hand bar (referred to inserted key) is not fully upwards, try pushing the key head gently to insert the key into the clamp.
- **When the fitting bar is fully up, do not push the key any further.**
- If the top bar shown on the display is not a fine line, turn the clamp slightly to the right or left until it appears as required.
- The better alignment, the better reading will be of stem or bit length.

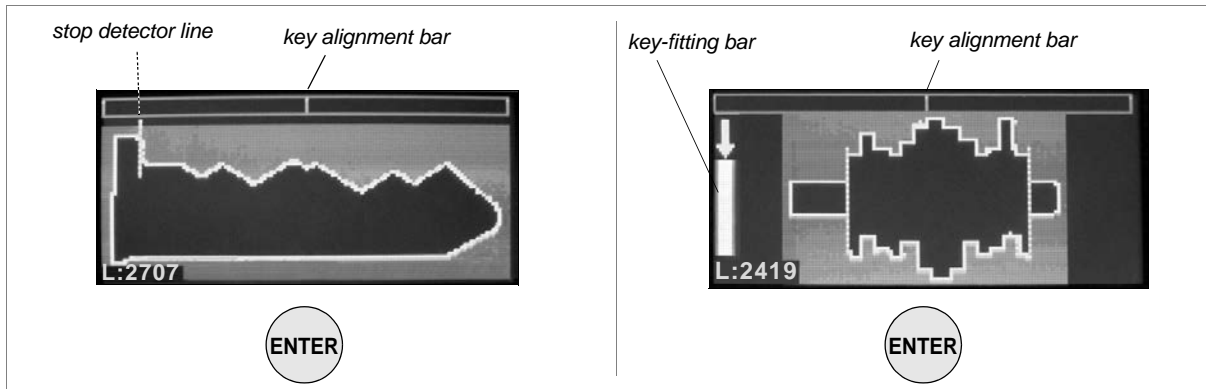

Fig. 22

- Before confirming the reading, press the ENTER button and make sure the key is actually aligned (the top yellow bar should be just a vertical line and the left-hand yellow bar should point upwards as much as possible).
- A downward arrow on the insertion bar (left) indicates that the key has been inserted too far inside. It is advised to gradually pull out the key until the arrow no longer appears.
- Press the ENTER push button and the display will show a new image.

6.1.3 STEP 2: VIEWING THE PROFILE

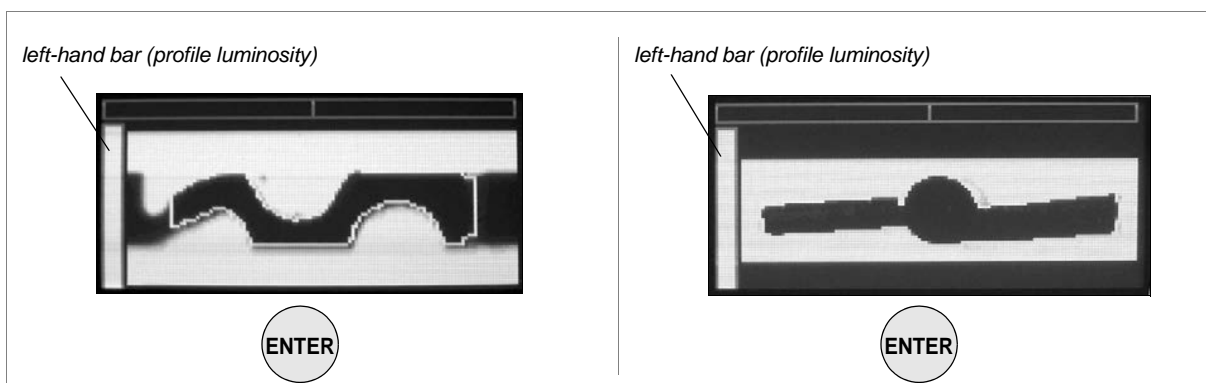

Fig. 23

If the left-hand bar (referred to the luminosity of the profile) on the display is not completely upwards, lightly push the key head so that it advances well into the clamp, or pull it out slightly.

The end of milled channels must be beneath the illuminators in any case. Sometimes the profile and the surface condition of the key do not allow it to extend completely (the left-hand bar could be half-way). With a left-hand bar below 70% of the total, key recognition is either not good and/or wrong.

If the upper bar is not a thin line on the display, turn the clamp/key slightly right or left until it reaches the best possible condition.

However, it is important that the outline of the profile is well defined; at times it is necessary to find a compromise between the thickness of the upper alignment bar and the image of the profile.

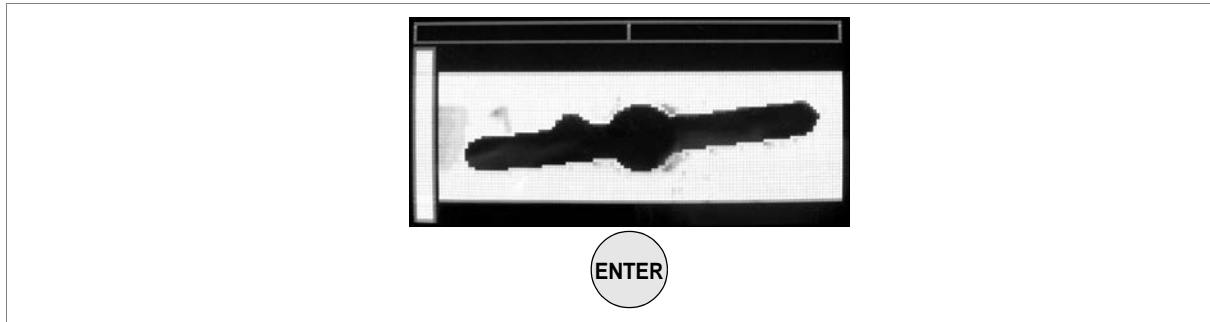

Fig. 24

- For bit keys, if the profile appears to slope (fig. 24), it must be aligned horizontally so that the cuts can be read properly.
 - If the key has been rotated a great deal to do this, the previous step **MUST** be repeated (“view cuts”) so that cut sizes can be read properly.
 - Then, turn the clamp/key slightly to the left or right until the top bar shows a thin line (fig. 23). Make sure the profile outline is well defined with reference to the “profile luminosity bar”.
- Press the ENTER button to start a search. A few seconds later the display will show the result of the search, comprising a list of the keys found. Examples:

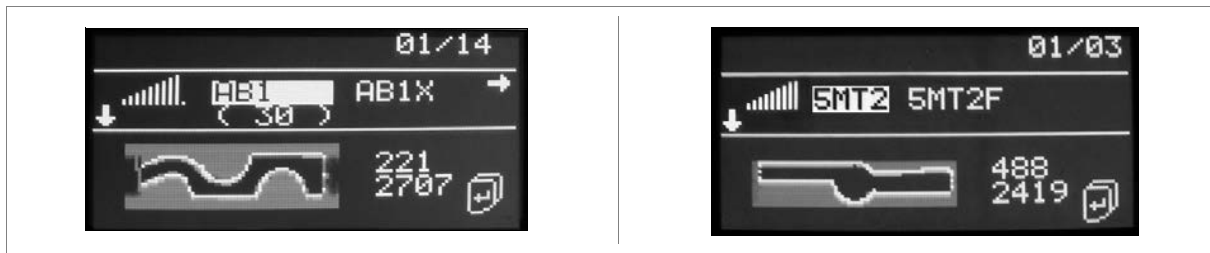

Fig. 25

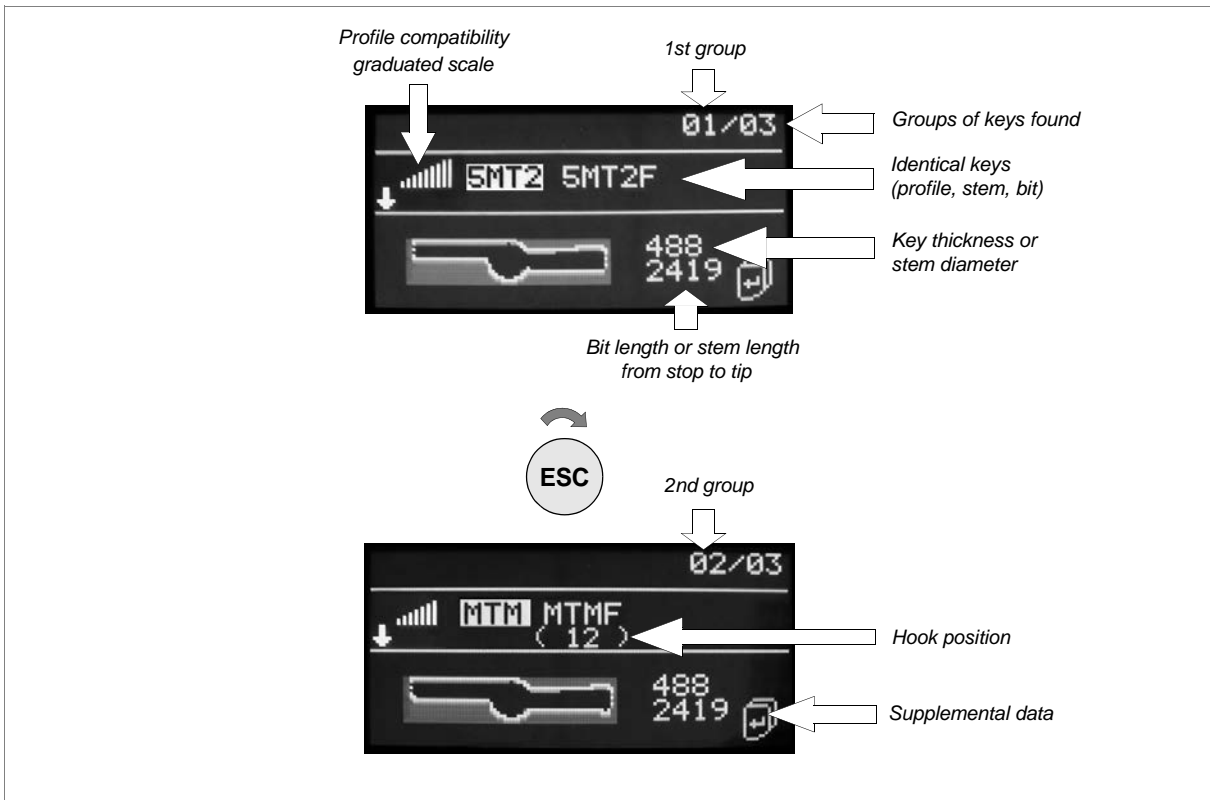

Fig. 26

- Identical keys (same profile and stem length or bit length) will be shown on the same line, separated by a space (fig. 26).
- Characters in brackets [E.g.: (A001), (A002) etc...] under the name of the key will blank show the hook number (if entered by an operator using the "Key Reader program" from a PC).
- 01/03 = first group of 3 found (fig. 26)
1st group = highly compatible (see graduated scale)
next groups = quite or not very compatible

 graduated scale = the more it's extended, the more compatible the profile is

Viewing groups and key blanks

- ESC knob rotation scrolls the group of keys (clockwise scrolls down, anticlockwise scrolls up).
- ENTER knob rotation scrolls the key blanks in the same group (anticlockwise scrolls left, clockwise scrolls right).

If the first search gives no results the display will show the following message:

```

The reading of the
profile is not
precise.
Reposition the key
and read again
  
```

The search has produced no results. Among possible causes:

- ***incorrect positioning of the key,***
- ***search parameters too strict,***
- ***no Silca reference matches the key blank read***

It is advised to correctly reposition the key by following all the instructions previously explained (see ch.6.1.1) and read the key again.

If the second search produces no results, the following message will appear:

```

No key found!
Press ENTER
to start a
broader search
  
```

By pressing ENTER, a search with temporarily broader parameters will be launched (the original parameters are never modified).

If the broad search produces no results the following display will appear:

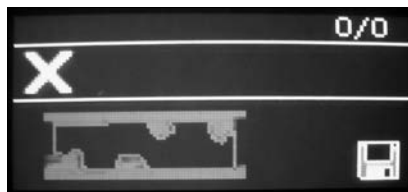

At this point the search has not been able to find any proper reference among Silca or User profiles. It is advised to save the profile as a User Profile if it is to be included in the Database as a reference for upcoming searches.

6.1.4 SPECIAL CASES

a) SMALL FLAT KEY - HEAD STOP (WITH PLASTIC HEAD)

If the distance between the end of the plastic part and the stop is small, impeding proper viewing of the stop cursor, proceed as follows:

- 1) Lower the clamp-opening lever (B) and without exerting pressure fit the key into the clamp until the stop is visible (fig. 27-1) and the cursor is in the right position.
- 2) Align the upper bar and press ENTER; in this way the stem length reading is precise.
- 3) Pull the key out slightly (fig. 27-2), release the clamp-opening lever to keep the key in place, then with the alignment bar centred and illumination bar up, press ENTER.

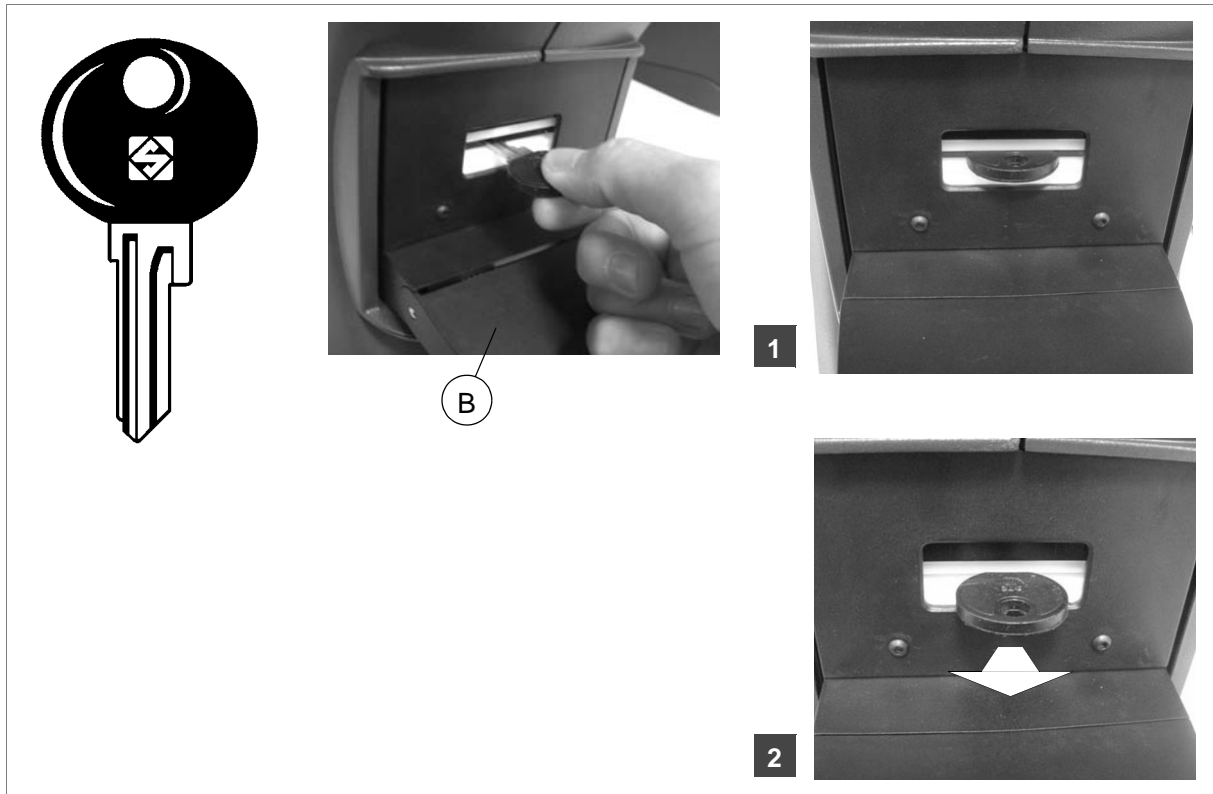

Fig. 27

b) VEHICLE KEY WITH LASER TYPE CUTS

With a cut key the profile is read properly and recognized only if the cuts have not touched or altered the part used for recognition.

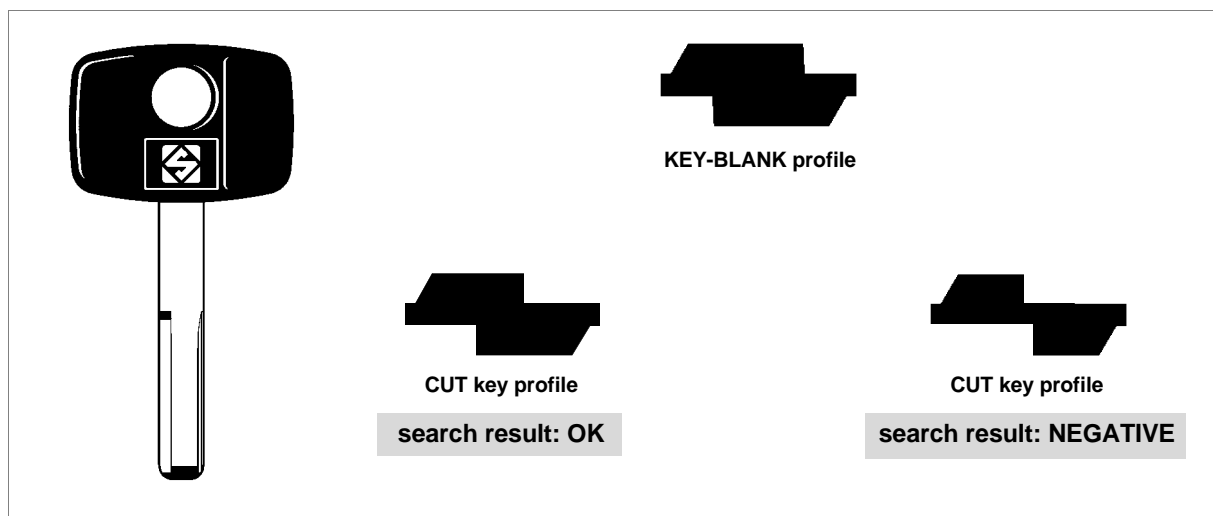

Fig. 28

c) SHORT-STEMMED MALE AND FEMALE BIT KEYS

If the distance between the end of the bit and the light shade device is small (short stem) and when reading the cuts the left-hand bar cannot face fully upwards (referred to inserted key), proceed as follows:

- 1) STEP 1: fit the key into the clamp without the light shade device and try to view a sufficient amount of stem (fig. 29-B).
- 2) press ENTER.
- 3) remove the key and fit the light shade device.
- 4) STEP 2: fit the key again with the light shade device (fig. 30-B) and press ENTER.

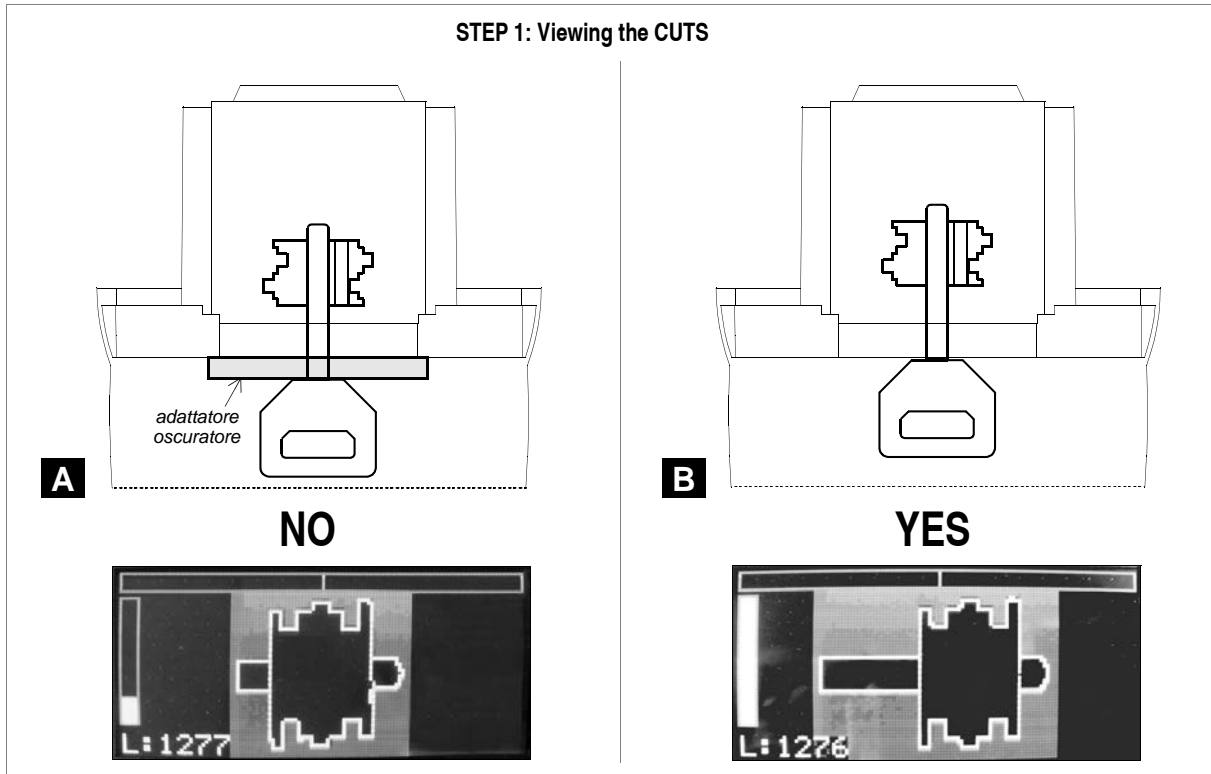

Fig. 29

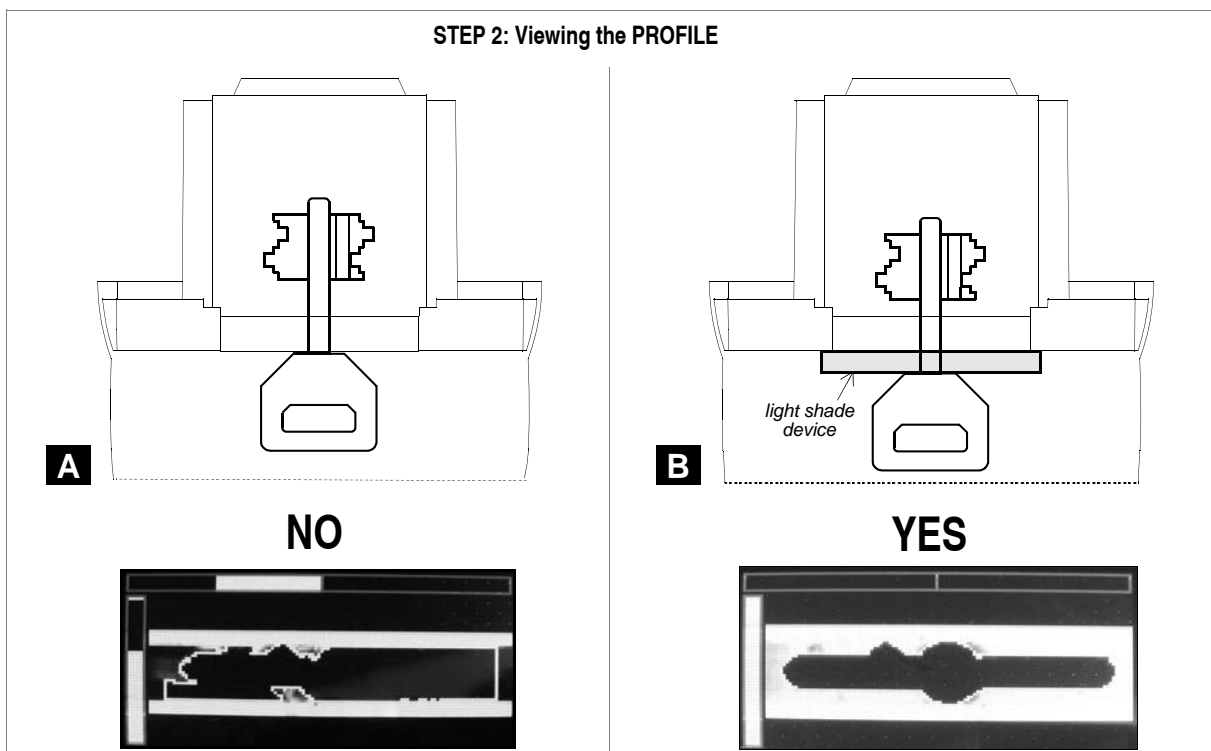

Fig. 30

d) PUMP KEY WITH EXTRA SHORT STEM

For pump keys with extra short stems we suggest using the procedure described above.

6.1.5 SUPPLEMENTARY SEARCH DATA

After "Key search" press ENTER, the following display will appear:

Menu selection:
Key copy
Ignore length
Profile info
Save profile
Search by key Manuf.
Search types

1 - KEY COPY

When this function is enabled it is used to transmit the cutting data for a bit key to the IDEA electronic key-cutting machine to make one or more copies. For further details about this function consult ch. 6.3, page 37.

2 - IGNORE LENGTH

This function allows to repeat a search ignoring the bit or stem length.

It is particularly useful when the stem or bit length is altered.

The function is only available for shoulder stop flat keys and all types of bit, double bit and pump keys.

By pressing ENTER the following message will appear:

The search will be repeated without considering bit length

Press ENTER to start the search.

3 - PROFILE INFO

Press ENTER, a list will appear of references to spare key manufacturers different from the Silca reference blank (found by searching with Optika) and highlighted on the last line on the bottom of the display:

Comparatives
ERREBI :AU5D
BOERKEY :743L
ORION :ABS17
LOTUS :U20
AB1 : SILCA

- Turn the ENTER knob to scroll the list of comparatives.

- Press ENTER, a list will appear of alternative articles:

Alternatives
AB1X
AB1BZ
AB1Q
AB1DA
AB1 : SILCA

4 - SAVE PROFILE

The following display will appear:

Save read profile
Name :
Make :
Hook :



- 1) Turn the ENTER knob to select the field into which the data will be entered.
 - The selected field will be highlighted in yellow.
- 2) Press ENTER; the display will show a list of characters:

A	B	C	D	E	F	G
H	I	J	K	L	M	N
O	P	Q	R	S	T	U
V	W	X	Y	Z	0	1
2	3	4	5	6	7	8
9	-	%	/	&	_	#

- Turn the left-hand ESC knob to scroll the fields up and down.
- Turn the right-hand ENTER knob to scroll the fields from left to right; choose the character and press ENTER to confirm.
 - *Going on to the next character the proposed letter is the last one selected.*

- Characters permitted:

Name: 0123456789ABCDEFGHIJKLMNQRSTUWXYZ%&/_
 Make: 0123456789ABCDEFGHIJKLMNQRSTUWXYZ%&/_
 Hook: 0123456789ABCDEFGHIJKLMNQRSTUWXYZ%&/_

- MAX limit for fields:

Name: max 14 characters
 Make: max 14 characters
 Hook: max 8 characters

- **To delete the last edited character:**

- select the "#" character, bottom right of the display and press ENTER.

- **To save a text:**

- press ESC to exit, then press ENTER to confirm.

- **To save a read profile:**

- select the "Save" symbol (disk) and highlight by turning the ENTER knob, then press the knob in.

A new key blank can be saved with an existing name, which will be overwritten by the new reading. The key blank name is required (at least one character). The key blank name must be unique in the database. Key blanks with the same name cannot be used.

Note: if no name is given to a key blank, it will not be saved.

5 - SEARCH by KEY MANUFACTURER

Used to filter the results of a search by cylinder or lock make (manufacturer). In this way the result from possible Silca references is more selective.

To quit the function Search by Make without keeping the set make, press the ESC button repeatedly until the initial menu appears.

- open a window with the current choice highlighted.
- use the ESC knob to scroll the initials that trigger updating of the list, with the first make starting with the selected letter highlighted.
- use the ENTER knob to scroll makes in alphabetical order.
- use the ENTER knob to select the MAKE filter.

Search by key Manuf.
296
333
4TR
606
=>A

After selecting the Make filter a search is launched for the profile previously loaded with the new criterion or set filter.

If there is no result after a search by make, the possible condition is:

- The key is a new original one not yet produced by Silca S.p.A.
- The profile of a loaded key can be saved by associating it to its manufacturer.

6 - SEARCH TYPE

Press ENTER to view the message:

Select search type:
Fine
*Standard
Extended

- Turn the ENTER knob to select the required setting. Press ENTER to confirm the setting (the display will also show the selection symbol).
- Press ESC to return to the previous menu, and press again to repeat the search using the parameters of the new setting selected.

Note: in the case of a search type different from the previously selected one, in order to make the new option operative the search for a key must be started again from the initial menu.

6.1.6 POSSIBLE ERRORS IN THE “KEY SEARCH” FUNCTION

Insert the key with the bit to the left

Appears if the bit or flat key is single sided and the bitting is facing right.
Remove the key and insert it with the bitting facing left.

The reading of the profile is not precise. Reposition the key and read again
--

Appears if the reading of the profile inserted is not precise due to wrong positioning [see ch.6.1.1]
Position the key correctly and read again.

6.2 Key Matching

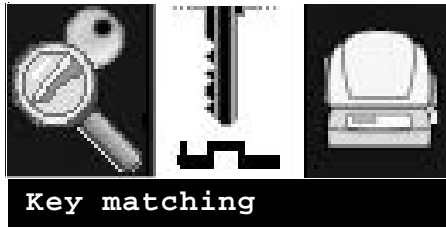

Function used to compare (assess) the difference in the cutting values of one or more cut keys with an original key. The function also checks compatibility of the key profile with the original.

Note: the device detects and indicates the differences found, and does not give a result regarding the functionality of the cut key.

ATTENTION:the key matching function is currently not available for key types:

- Flat (for cylinders or vehicles) with double asymmetrical cuts (different cuts on the 2 sides).
- Dimple keys
- Laser type keys
- Special bit keys (special female front stop and special square stem) with unusual stems or bits:

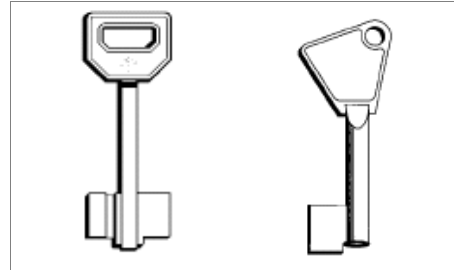

- **Bit keys with shoulder stop**

This type of key is run only in “Key matching” and “Key copy” modes and requires the use of a special adapter. Use of the adapter is explained in ch. 5.4.4, page 14.

- **Special keys as indicated in the following chart:**

Make	Silca Ref.
Abloy	AY1, AY2 ...
Abus	AB32, AB38P ...
Ford	FO19P, FO21P ...
Tibbe	TBE1P, TBE2P ...

Note: as these keys are duplicates, make sure they are carefully cleaned (profile and cuts) (use the brush provided).

Note: for more accurate cut comparisons, follow all the key fitting procedures in ch.5 and all the instructions in ch.6.

- 1) Press ENTER, the display will show:

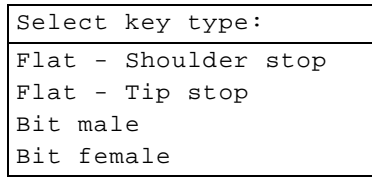

- 2) Turn the ENTER knob to select the type of key to be searched for (the description will be highlighted by a yellow strip over black characters).
- 3) Press the ENTER button and the display will show the message (the same for all types of keys):

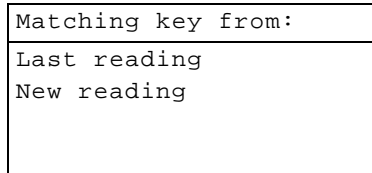

There are 2 ways of using "Compare Cuts".

- Select "New Reading" when in Optika's memory there is NOT a read key, useful for the comparison.
- Select "Last Reading" when in Optika's memory there is a read key, useful for the comparison.

6.2.1 MATCHING FROM "NEW READING"

- 4) Turn the ENTER knob to "New reading" and press ENTER to confirm; the display will show:

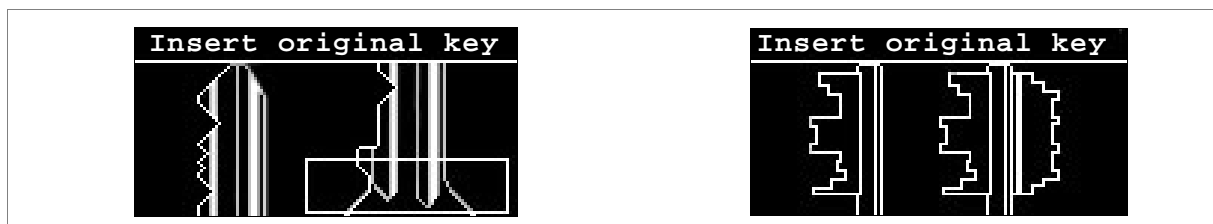

- 5) Fit the original key.

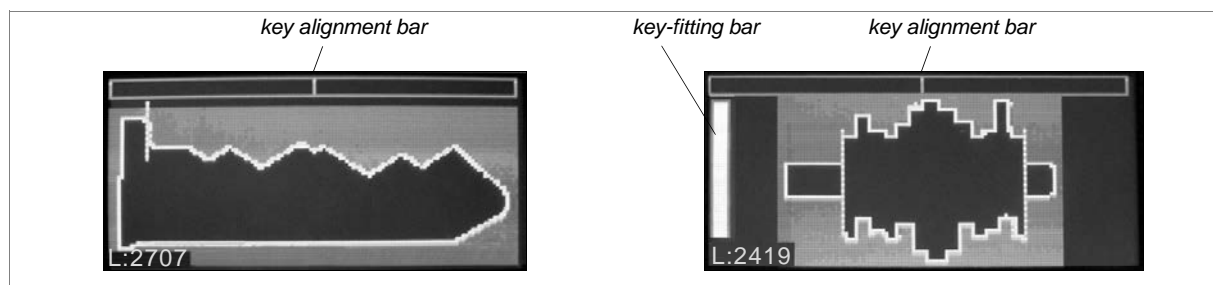

Fig. 31

- 6) Before confirming the reading operation, press the ENTER button to make sure the key is properly aligned (the top yellow bar must be just a vertical line). If not, follow the instructions in ch.6.1.
- 7) Confirm with ENTER, a few seconds later the display will show:

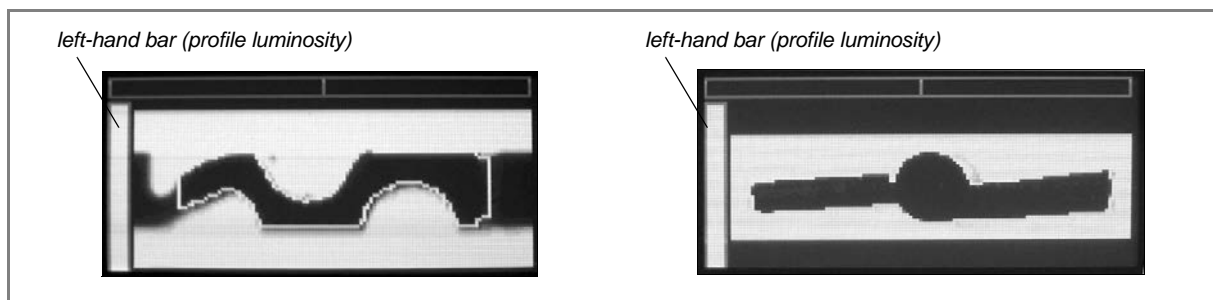

Fig. 32

- 8) Make sure the left-hand yellow bar should point upwards as much as possible. If not, follow the instructions in ch.6.1.

9) Confirm with ENTER, a few seconds later the display will show:



ATTENZIONE: the original key and the copy **MUST BE FITTED FACING THE SAME WAY**, i.e. the cuts and profiles must be properly overlaid (fig. 33 and fig. 34).

If not, the results of comparison will be negative or the following message will appear:

To obtain a correct
match rotate
the key of 180°!

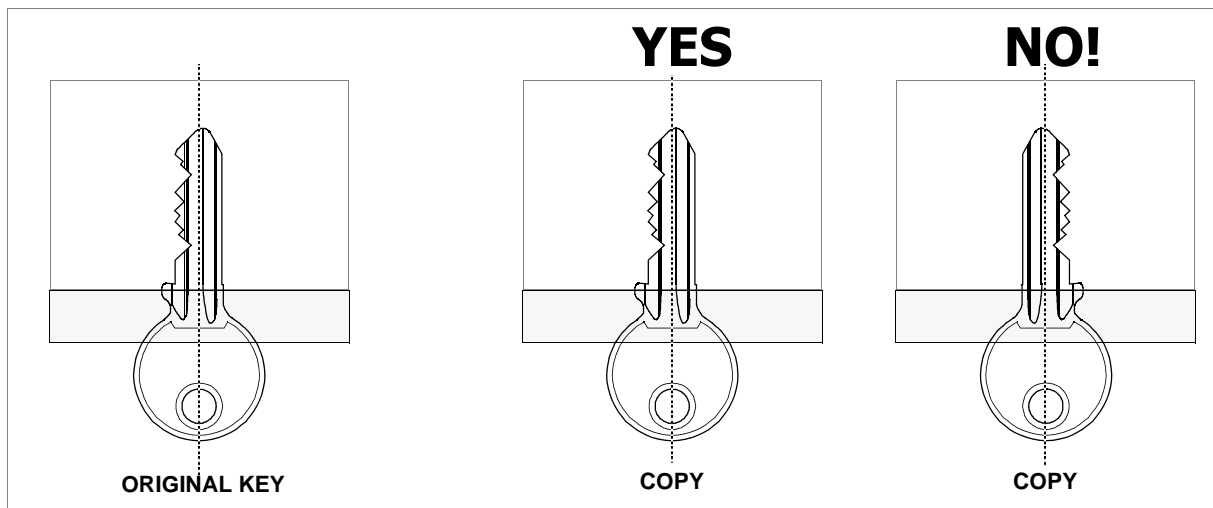

Fig. 33

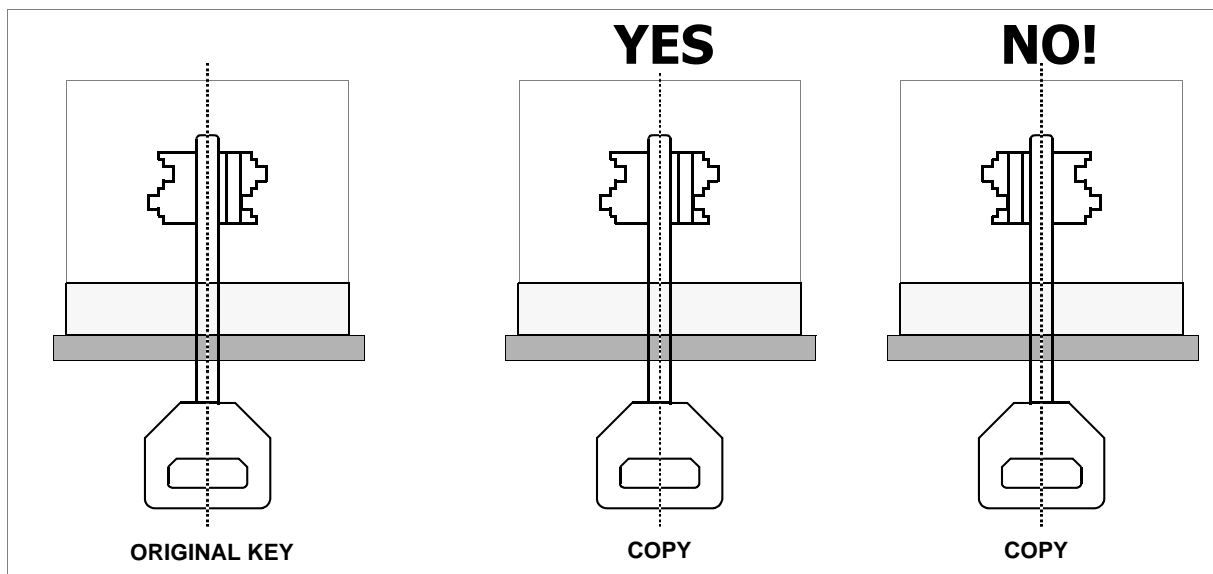

Fig. 34

10) Remove the key, fit the new key to be compared; press ENTER, the display will show:

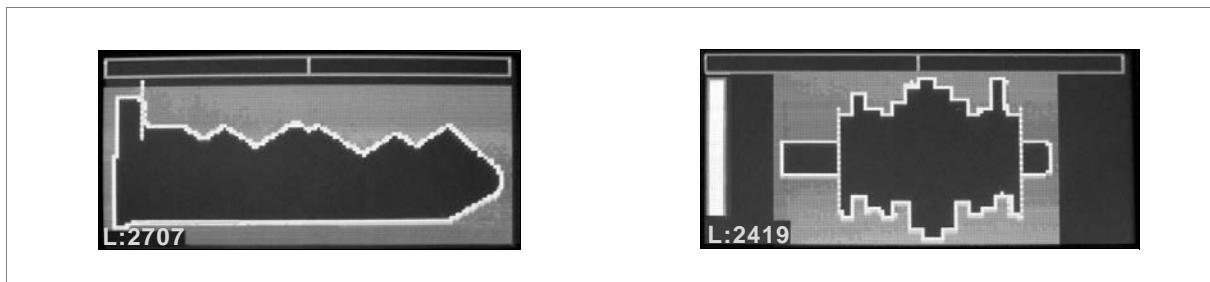
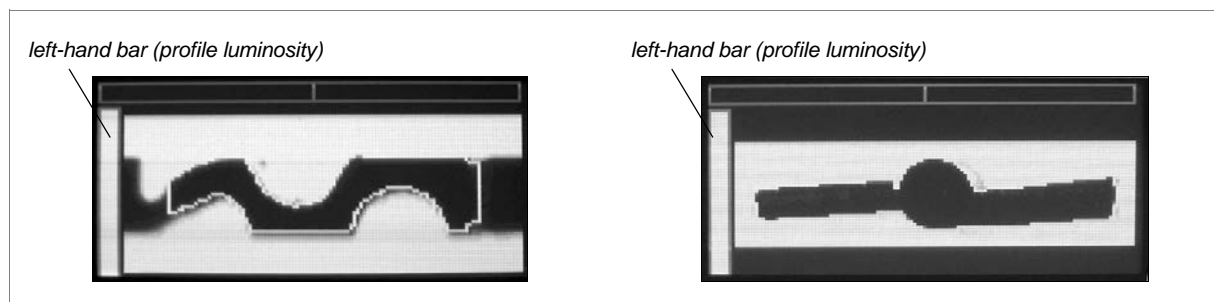

Fig. 35

11) make sure the key is properly aligned (the top yellow bar must be just a vertical line).

12) Confirm with ENTER, a few seconds later the display will show:



13) Make sure the left-hand yellow bar should point upwards as much as possible. If not, follow the instructions in ch.6.1.

14) Confirm with ENTER, a few seconds later the display will show the matching result (Examples):

EXAMPLE FLAT KEYS

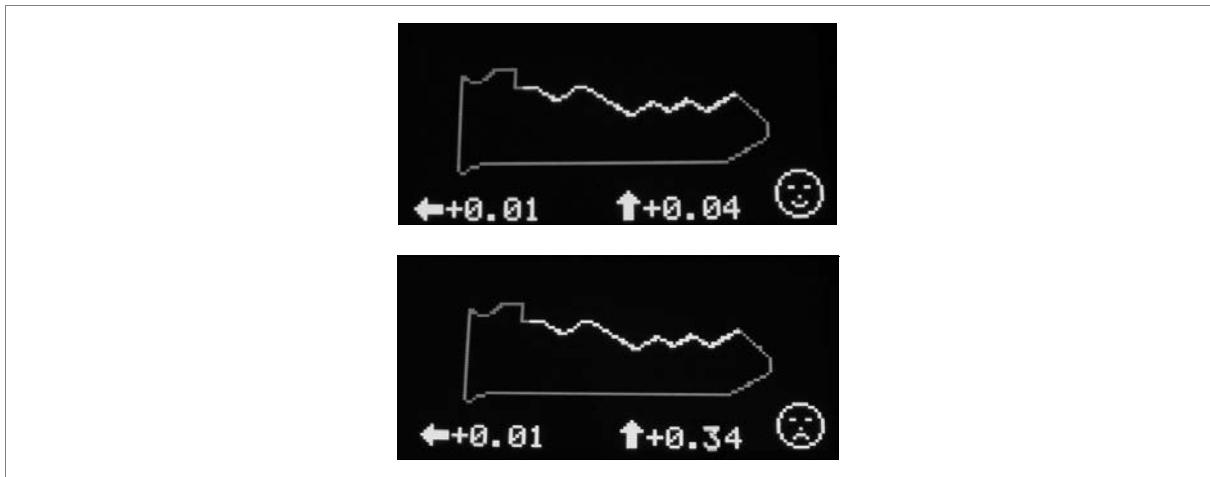



Fig. 36



The key shown in the results of comparison is always the copy.

Example: meaning of the symbols shown (arrows, values and faces).

-  smiling face = matching between keys is within the set parameters [Fine/Standard/By User] (*)
-  sad face = matching between keys is out of the set parameters [Fine/Standard/By User] (*)
- ↓ 0,03: cuts on the key compared with the cuts on the original key are deeper by 0,03 mm (0,0012 inch)
- ↑ 0,25: cuts on the key compared with the cuts on the original key are higher by 0,25 mm (0,0095 inch)
- ← 0,03:cuts on the key compared with the cuts on the original key are closer to the head by 0,03 mm (0,0012 inch)
- 0,10:cuts on the key compared with the cuts on the original key are closer to the tip by 0,10 mm (0,0038 inch)

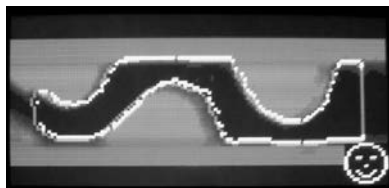
Press ENTER, the display will show the profile:



-  Smiling face= indicates positive result of the profile comparison (*)
-  Sad face= indicates negative result of the profile comparison (*)

(*) Results referred to the parameters set in OPTIONS -> Search type (ch.6.4.5).

- **Turn the right-hand knob (ENTER) to select side 1 or side 2.**

- Turn the left-hand knob (ESC) to access a detailed view of the individual teeth.

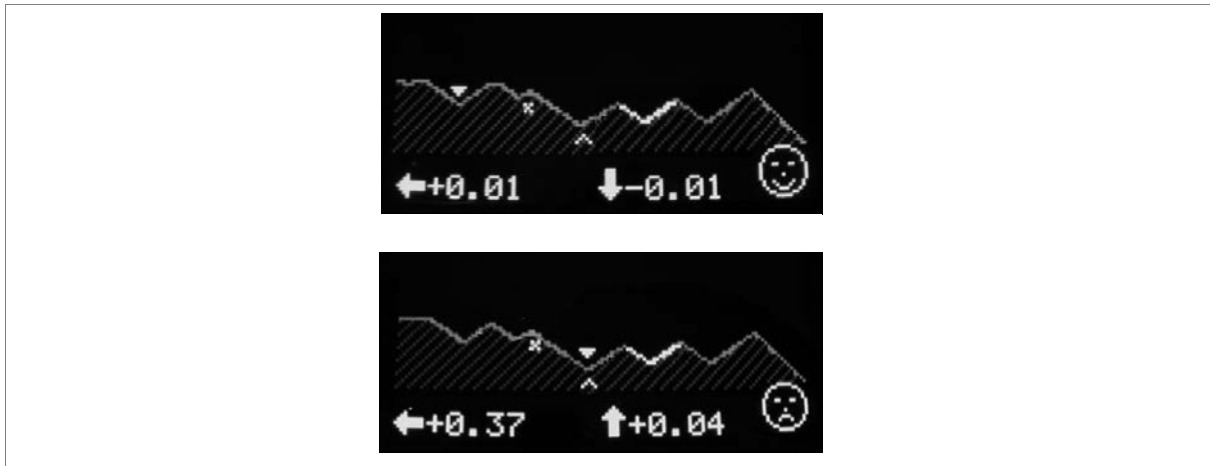









Fig. 37



Meaning of the symbols shown:

-  smiling face = matching between keys is within the set parameters [Fine/Standard/By User] (*)
-  sad face = matching between keys is out of the set parameters [Fine/Standard/By User] (*)
-  X indicates the position where there is a difference in the number of teeth on the copied key and the original key.
-  ^ indicates the position where there is a difference in interaxis measurement or depth between the copied key and the original key. The difference exceeds the tolerance set in the comparison parameters.
-  ↑ up arrow: indicates that the tooth on the copied key is higher than the one on the original key.
-  ↓ down arrow: indicates that the tooth on the copied key is lower than the one on the original key.
-  ← left-hand arrow: indicates that the selected interaxis on the copied key is more to the left than the corresponding interaxis on the original key.
-  → right-hand arrow: indicates that the selected interaxis on the copied key is more to the right than the corresponding interaxis on the original key.

(**) A highlighted tilted section indicates that the same section on the original and copy keys has a substantially different inclination angle.

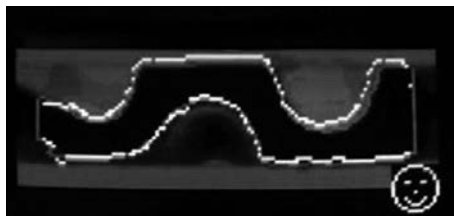
- Press ESC to exit the detailed view and return to the results of comparison.
- Press ENTER, the display will show the profile:



-  Smiling face= indicates positive result of the profile comparison (*)
-  Sad face= indicates negative result of the profile comparison (*)

(*) Results referred to the parameters set in OPTIONS -> Search type (ch.6.4.5).

MATCHING TYPE		
Values table (0,01mm)	FLAT KEYS	
	spaces	depths
<p><i>Standards set by Silca Cannot be edited</i> ➔</p> <p>FINE</p>	+/- 15 (0,004")	+/- 10 (0,004")
<p><i>Standards set by Silca Cannot be edited</i> ➔</p> <p>STANDARD</p>	+/- 30 (0,008")	+/- 20 (0,008")
<p><i>Values set or to be set by customer</i> ➔</p> <p>BY USER</p>	+/- 35	+/- 35

Note: choosing "Last reading" you start a new key matching function (eg. 2nd, 3rd, 4th... copy) compared to the original key.

EXAMPLE BIT KEYS

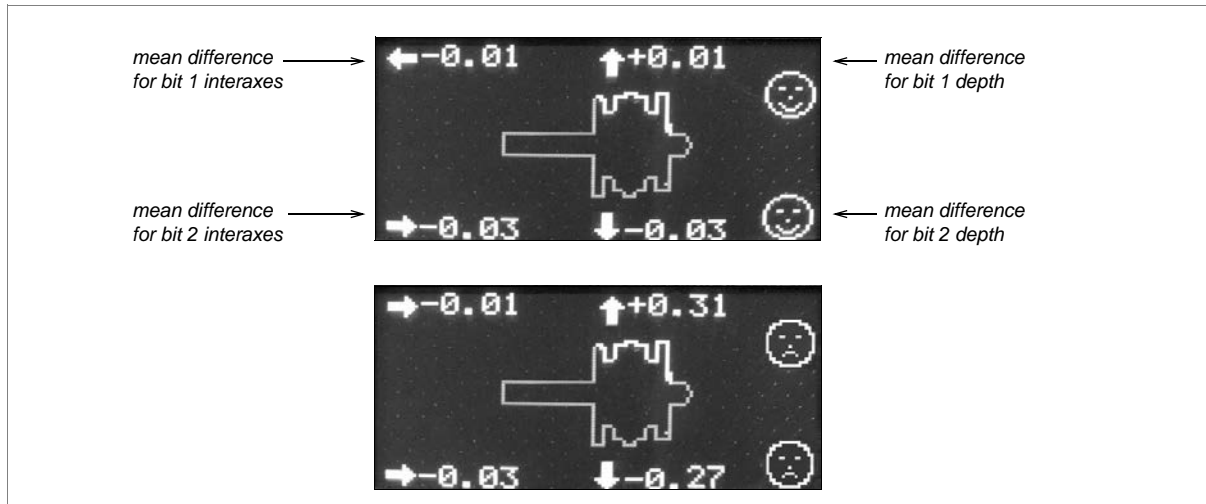

Fig. 38

The key shown in the results of comparison is always the copy.

Example: meaning of the symbols shown (arrows, values and faces):



smiling face = matching between keys is within the set parameters [Fine/Standard/By User] (*)



sad face = matching between keys is out of the set parameters [Fine/Standard/By User] (*)



0,03: cuts on the key compared with the cuts on the original key are deeper by 0,03 mm (0,0012inch)



0,31: cuts on the key compared with the cuts on the original key are higher by 0,31 mm (0,012 inch)



0.01: cuts on the key compared with the cuts on the original key are closer to the head by 0,01 mm (0,0004 inch)



0.03: cuts on the key compared with the cuts on the original key are closer to the tip by 0,03 mm (0,0012 inch)

- Turn the right-hand knob (ENTER) to select bit 1 or bit 2.

- Turn the left-hand knob (ESC) to access a detailed view of the individual teeth.

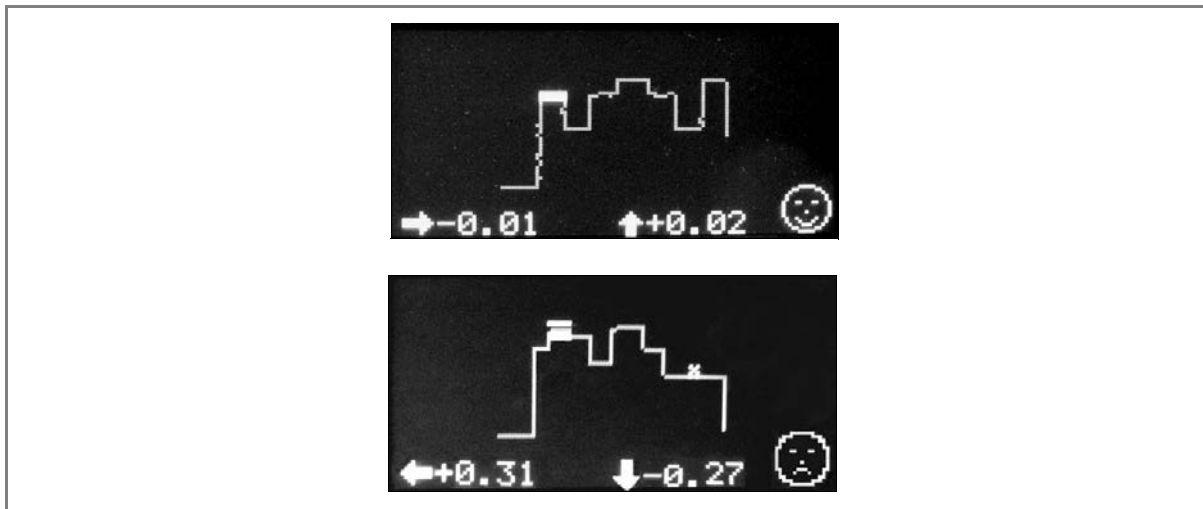



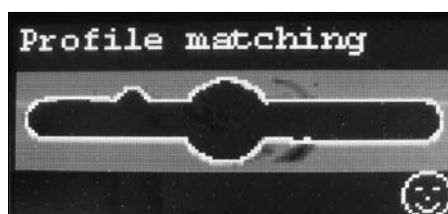



Fig. 39

Meaning of the symbols shown:

-  smiling face = matching between keys is within the set parameters [Fine/Standard/By User] (*)
-  sad face = matching between keys is out of the set parameters [Fine/Standard/By User] (*)
-  indicates the position where there is a difference in the number of teeth on the copied key and the original key.
- indicates the position where there is a difference in interaxis measurement or depth between the copied key and the original key. The difference exceeds the tolerance set in the comparison parameters.
- ↑ up arrow: indicates that the tooth on the copied key is higher than the one on the original key.
- ↓ down arrow: indicates that the tooth on the copied key is lower than the one on the original key.
- ← left-hand arrow: indicates that the selected interaxis on the copied key is more to the left than the corresponding interaxis on the original key.
- right-hand arrow: indicates that the selected interaxis on the copied key is more to the right than the corresponding interaxis on the original key.

- Press ESC to exit the detailed view and return to the results of comparison.
- Press ENTER, the display will show the profile:



-  Smiling face= indicates positive result of the profile comparison (*)
-  Sad face= indicates negative result of the profile comparison (*)

(*) Results referred to the parameters set in OPTIONS -> Search type (ch.6.4.5).

MATCHING TYPE		
Values table (0,01mm)	BIT KEYS	
	spaces	depths
Standards set by Silca Cannot be edited → FINE	+/- 15 (0,006")	+/- 15 (0,006")
Standards set by Silca Cannot be edited → STANDARD	+/- 25 (0,010)	+/- 25 (0,010")
Values set or to be set by customer → BY USER	+/- 35	+/- 35

Note: choosing "Last reading" you start a new key matching function (eg. 2nd, 3rd, 4th... copy) compared to the original key.

6.2.2 MATCHING FROM "LAST READING"

Last Reading: in Optika's memory there is always the last key read (regardless of whether the "Key Search" or "Key matching" functions have been used). Therefore, if with an "original" key the "Key Search" function had been used to find the corresponding reference, the copy made can be compared by using "Last Reading". The same applies if a number of copies made from the same "original" have to be compared.

The "New Reading" function is used if the "original" key to be compared with the copy was not the subject of a search or already compared.

ATTENTION: if "Last Reading" has been chosen and a type of key different from that in the memory (e.g. bit and head stop) is fitted into the clamp, the display shows an anomaly message:

```
The key type select.
is not equal to
the original key
saved in memory
```

6.2.3 POSSIBLE ERRORS DURING "CUT MATCHING"

```
Cut comparison
is not possible!
Error ...
```

ERRORS 13 and 14:

It happens when there isn't a correct alignment between the two keys in terms of spaces and depths references. The possible causes could be: keys too different or not compatible.

ERRORS 15 and 16:

It happens when the device SW can't calculate the average error of spaces and depths of the cuttings. The possible causes could be: the keys are too different or the gap between the two cuttings is too high.

```
The cuttings of
the inserted keys
cannot be matched!
repeat the operation
```

The message indicates that there is too much difference between the cuts and they cannot be compared within the limits defined by the program. Check that the two keys compared are similar and repeat the procedure, if necessary. If the error remains try comparing the original key and copied key turned 180°.

The reading of the
bitting is wrong!
Reposition the key
and read again

This message indicates that the bitting of the key just read is not been correctly reconstructed and therefore not available for comparison.
Reposition the key and read again.

No cut key
reading is
available for
comparison

This message appears only In “Comparison from last reading” when no bitting has been previously saved for the comparison.

Among possible causes:

- no key is been actually read previously.
- the reconstruction of the bitting previously read is not correct.

Repeat the comparison of the original and copy key as a “Comparison from new reading”.

6.3 Key copy

Transmission to the IDEA electronic key-cutting machine

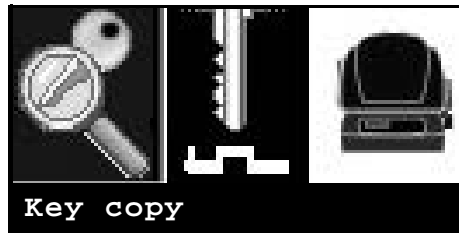

The Optika device is used to read then transmit the cuts of a bit key directly to the IDEA key-cutting machine without the aid of a personal computer. Optika can be used as an alternative to the optic reader on the IDEA key-cutting machine, considerably reducing reading times.

ATTENTION:

- **The cuts on a bit key read by Optika can be transmitted only to the IDEA electronic key-cutting machine**
- **Before transmitting the key to be cut, make sure that:**
 - the key-cutting machine is live
 - the key-cutting machine is not in motion
 - OPTIKA and the key-cutting machine are connected with a serial cable with adapter found in the OPTIONAL KIT (fig. 40).

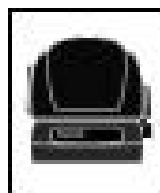

Fig. 40

The cuts on the key to be read with Optika can be transmitted to the key-cutting machine in the following ways:

6.3.1 Transmission from main menu

In the main menu select the "Key copy" icon:



- 1) press ENTER
- 2) select the type of bit key to be read
- 3) continue as with an ordinary search

In the place of the results of an ordinary search the material selection and number of pieces menu will appear.

```
MATERIAL :
PIECES :
[ TRANSMIT ]
```

- 4) Turn the ENTER knob to select the field.
 - **the selected field will be highlighted in yellow.**

- 5) When the field "material" or "pieces" is selected, turn the ESC knob to select the type of material of the key blank to be used for the copy or to increase/decrease the number of pieces to be cut.

Default values are:

- **Material = last material selected**
- **Pieces = 1**

- 6) When the field "[Transmit]" is selected:

- **press ESC to return to the main menu**
- **press ENTER to transmit the cuts to the key-cutting machine**

Note: the job will be received by IDEA in the "PC queue" and any jobs already in the queue will be deleted.

6.3.2 Transmission at the end of a search

When the results of a search for a bit key profile are shown, press ENTER to access the following menu:

```

Menu selection:
Key copy
Ignore length
Profile info
Save profile
Search by key Manuf.
Search types
  
```

- 1) select the item "Key copy"
- 2) press ENTER.
- 3) the menu for entering material and number of pieces will appear
- 4) continue as described above

6.3.3 Possible errors during communication with the key-cutting machine

```

Key-cutting machine
in motion or unable
to receive data
from PC!
  
```

Appears during transmission, when the key-cutting machine is unable to receive data because it is on start-up or in motion.

```

Operation not
possible with
connected machine
  
```

Appears if the key cutting machine connected to Optika is not the required one.

```

Major error
during transmission
  
```

Appears if during transmission there is an interruption in the serial connection or an error in the transmission data.

6.4 Options

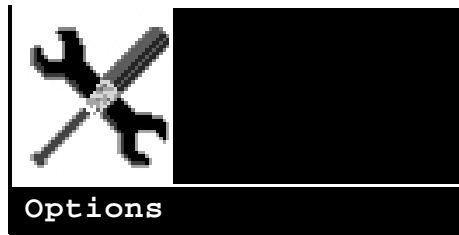

A series of operations, some merely consultations, by which users can familiarise with the device, customise it to their needs and check its operation.

Press ENTER; the display will show:

Select option:
Device data
Language
User profiles
Keys in stock
Search type
Matching type
Hardware test
SW Upgrade
Service menu

6.4.1 MACHINE DATA

After confirmation of this function the display will show:

Device data
Ser. 1122334455661
SW vers.:
DB vers.:
Keys read:

This is a read only display and the data shown cannot be edited.

6.4.2 LANGUAGE

After confirmation of this function the display will show a list of all the languages available on the device:

Italian
*English
French
German
Spanish

- Turn the ENTER knob (clockwise or anticlockwise) to select a language (field illuminated).
- Press the ENTER knob to view the selection asterisk.

Press ESC to go back to the previous menu; the language remains the one already in use.

Note: to make the chosen language operative, disconnect the device and wait 10 seconds before starting up again.

6.4.3 USER PROFILES

The choices are:

Select function:
Modify profile
Delete profile
Keys in memory

- Turn the ENTER knob (clockwise or anticlockwise) to select the required function (field illuminated). Press ENTER to confirm:

- **Modify profile (user key):**

After confirmation of this operation the display will show a list of the keys loaded into the database:

Select profile:
AAA
BBB
CCC
=>A

The left-hand side of the display will show a list of loaded keys and the right-hand side will show the initial letter for the key to be searched for.

- Turn the ESC knob clockwise to change the initial letter for the search. On the display a list of the keys loaded into the database will scroll.
- Turn the ENTER knob to scroll and select the key data to be edited.

After selecting a key press the ENTER knob and the display will show the following message:

Modify data:
Name: CCC
Manu: A
Hook: A

The same window will appear for entering data in the save profile function.

- **Delete profile (user keys):**

After confirmation of this function the display will show a list of the keys loaded into the database.

After selecting the profile, press the ENTER knob and the display will show the following message:

Select profile
AAA
BBB
CCC
=>A

- Turn the ENTER knob to scroll and select the profile (the article is highlighted). Press the ENTER knob to confirm.

Delete profile?	
<AAA>	
No	Yes

- Press the ESC knob to return to the previous menu without confirming deletion.

- **To delete profile:**

- turn the ENTER knob to select "Yes".
- press the ENTER knob to confirm deletion.

• **Keys in memory (user data):**

After confirmation of this function the display will show:

User key memory	
Max profiles:	300
Used	: 1
Free	: 299

This is a read only display, the data shown cannot be edited.

- Press the ESC knob to exit.

6.4.4 KEYS IN STOCK

Note: this function will be available in the next software release.

6.4.5 SEARCH TYPE

This item is used to collect all parameters for configuring the device with regard to searches in the profile database and comparisons of cuts.

After confirmation of this function the display will show:

Select search type
*Fine
Standard
Extended

The possible settings (Fine - Standard - Extended) have been designed and defined by Silca to provide fine, medium or extended compatibility. According to the set search parameter the result will show a few or many key blanks.

6.4.6 MATCHING TYPE

Select matching type:
*Fine
Standard
By User

MATCHING TYPE					
Values table (0,01mm)	FLAT KEYS		BIT KEYS		
	spaces	depths	spaces	depths	
Standards set by Silca Cannot be edited ➔	FINE	+/- 15 (0,004")	+/- 10 (0,004")	+/- 15 (0,006")	+/- 15 (0,006")
Standards set by Silca Cannot be edited ➔	STANDARD	+/- 30 (0,008")	+/- 20 (0,008")	+/- 25 (0,010")	+/- 25 (0,010")
Values set or to be set by customer ➔	BY USER	+/- 35	+/- 35	+/- 35	+/- 35

If the "BY USER" option is selected, press ENTER again to view the window:

Flat	Bit
Space 40	Space 40
Depth 40	Depth 40
	

- turn the ENTER knob to go from one field to another.
- turn the ESC knob to edit a value (range 0-99).
- select the "Save" symbol (disk) and highlight by turning the ENTER knob. press the ENTER knob to confirm the set values.

6.4.7 TEST HARDWARE

This paragraph presents all the tests necessary to check the optics and/or electronics of the device. After confirmation of this function the display will show a list of all the tests available:

Select test:
Check adjustment
Check profile area
Check cuts area
Camera & led
Display
Keyboard

If there are problems the display will show the type of fault.

6.4.7.1 CHECK ADJUSTMENT

Note: we recommend that you perform this procedure at least once a year.

This function is used to check machine gauging.

Check adjustment
Insert template Z23

- 1) Fit the Z23 template as if it were a flat key, making sure that the special stop is facing downwards and butting against the illuminator (fig. 41).



Fig. 41

- 2) Standard key alignment procedure.
- 3) After confirmation the following display will appear (examples with purely indicative values):

Example 1:

Detected values:
dL: 0.030001
dL: 0.050000
dT: 0.015000

Example 2:

Detected values:
dL: 0.030001
*dL: -8.350000
*dT: -2.150000

Example 1: satisfactory gauging

Example 2: the asterisk shows that gauging is not satisfactory (values out of range). Contact Silca's Technical Assistance Dept.

6.4.7.2 CHECK PROFILE AREA

Note: this operation is necessary when the image is out of focus or faulty and must be carried out only on the advice of SILCA after-sales staff.

The operation is used to detect/gauge the area into which the profile could extend. The display will show:

Check profile area
Attention before proceeding see instruction manual ENTER to continue

Check profile area
If this operation is not performed correctly it will cause a malfunction of the machine

Check profile area
Make sure there are no keys or templates in the clamp ENTER to continue

Check profile area
Open and close the clamp

- Flashing illuminators.
- Use lever (B) (fig. 7, page 7) to open and close the clamp when the white led is flashing; every flash should correspond to one position. The positions must vary from maximum opening to closed, including the intermediate positions.

Note: It is important that the clamp is on one position every time the led flashes, and is re-positioned before the next flash.

The procedure can be repeated a number of times if you are not sure it has been carried out properly.

- When the illuminators stop flashing the display will show:

Check profile area
Open and close the clamp
Check completed

Press ESC to go back to the previous menus.

6.4.7.3 CHECK CUTS AREA

Note: this operation is necessary when the image is out of focus or faulty and must be carried out only on the advice of SILCA after-sales staff.

The operation is used to gauge the clamp illumination area (position of key).
The display will show:

Check cuts area
Turn the clamp right and left

- Turn the clamp (A) (fig. 7, page 7) right and left during flashing, making sure that every flash of the red led corresponds to one position. The positions must vary from the far right to the far left, including the intermediate positions.

ATTENTION: do not open the clamp during rotation.

Note: It is important that the clamp is on one position every time the led flashes, and is re-positioned before the next flash.

The procedure can be repeated a number of times if you are not sure it has been carried out properly.

Check cuts area
Turn the clamp right and left
Check completed

Press ESC to go back to the previous menus.

6.4.7.4 TELECAMERA and LED

Note: this function will be available in the next software release.

6.4.7.5 DISPLAY

Note: this function will be available in the next software release.

6.4.7.6 KEYBOARD

Note: this function will be available in the next software release.

6.4.8 UPDATING OPTIKA INTERNAL PROGRAM

A) UPDATING/LOADING OPTIKA's INTERNAL PROGRAM THROUGH A SERIAL CONNECTION (40-50 minutes)

The updating of Optika's internal program is allowed at these conditions:

- a) the device is connected and switched on.
- b) it is connected to a PC (through serial port and cable)
- c) you have an updated Silca program:
 - **Silca Key Program**
 - **Key Reader Program (CD provided with the machine)**

The programs contain an on-line guide for the procedure.

B) UPDATING/LOADING OPTIKA's INTERNAL PROGRAM THROUGH A USB PEN-DRIVE (5-10 minutes)

The updating of Optika's internal program can be done with a USB pen-drive properly prepared with Silca Key Program (Key Reader Program).

- 1) open the Silca Key Program (or the Key Reader Program provided with Optika).
- 2) select the Optika device from the "Machine table" menu.
- 3) click on the "Advanced..." button.
- 4) select the "USB flash memory" tab and follow all the instructions there reported.
- 5) once the pen-drive has been prepared, select "SW Upgrade" from Optika's "Options" menu.

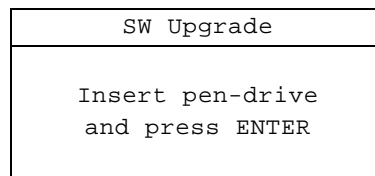

C) LOADING OPTIKA's INTERNAL PROGRAM FOLLOWING A STATE OF RECOVERY (60 minutes)

When Optika shows the following message at startup:



It is possible to recover the internal program at these conditions:

- a) the machine is running and the "RECOVERY" message is displayed.
- b) it is connected to a PC (through serial port and cable)
- d) you have an updated Silca program:
 - **Silca Key Program**
 - **Key Reader Program (CD provided with the machine)**

The programs contain an on-line guide for the procedure.

ATTENTION: communication between a PC and the Optika USB (slave) will be available with a future software release.

6.4.9 SERVICE MENU

Function protected by password.

Access is granted to Silca personnel only or to centres authorized by Silca to carry out work on this type of device.

7 MAINTENANCE

Note: all internal tests and repairs on this device should be performed only at Silca or Authorised Centres.

ATTENTION: for repairs or replacement of parts for maintenance, the 'CE' mark is guaranteed only if original spare parts provided by the manufacturer are used.

The OPTIKA device does not require special maintenance.

Replacement is simple and can be carried out by the operator.

CLEANING: your OPTIKA device should be kept in a relatively dust-free area; clean the surface periodically with a vacuum cleaner.

ATTENTION: DO NOT USE COMPRESSED AIR!

Before starting any type of maintenance (checks or replacements) read the instructions below:

- Never carry out maintenance operations when the machine is on;
- Always disconnect the mains power supply;
- Before replacing parts read carefully all the instructions given.
- Use only original spare parts;
- Check that screws and nuts removed in order to replace parts are properly tightened.
- Work in an environment with temperature of 10° to 40° C and relative humidity of approx. 60%.
- The work bench should be: clean, free from anything not strictly necessary, and covered with shock-proof material.
- Do not work with wet or greasy hands.

7.1 Clamp replacement

ATTENTION: we recommend carrying out this operation in a clean, dust-free environment.

- 1) Disconnect the machine power cable.
- 2) Completely unscrew the clamp fixing knob (P) (fig. 42).
- 3) Exert pressure with both hands on the clamp opening lever, remove the clamp from its seat and place on a clean surface.

ATTENTION: do not leave the device "open" (without the clamp) for too long (eventually cover the device).

- 4) Fit the new clamp, taking care to push it all the way in.
- 5) Block the clamp against its limit switch and firmly tighten the knob (P).

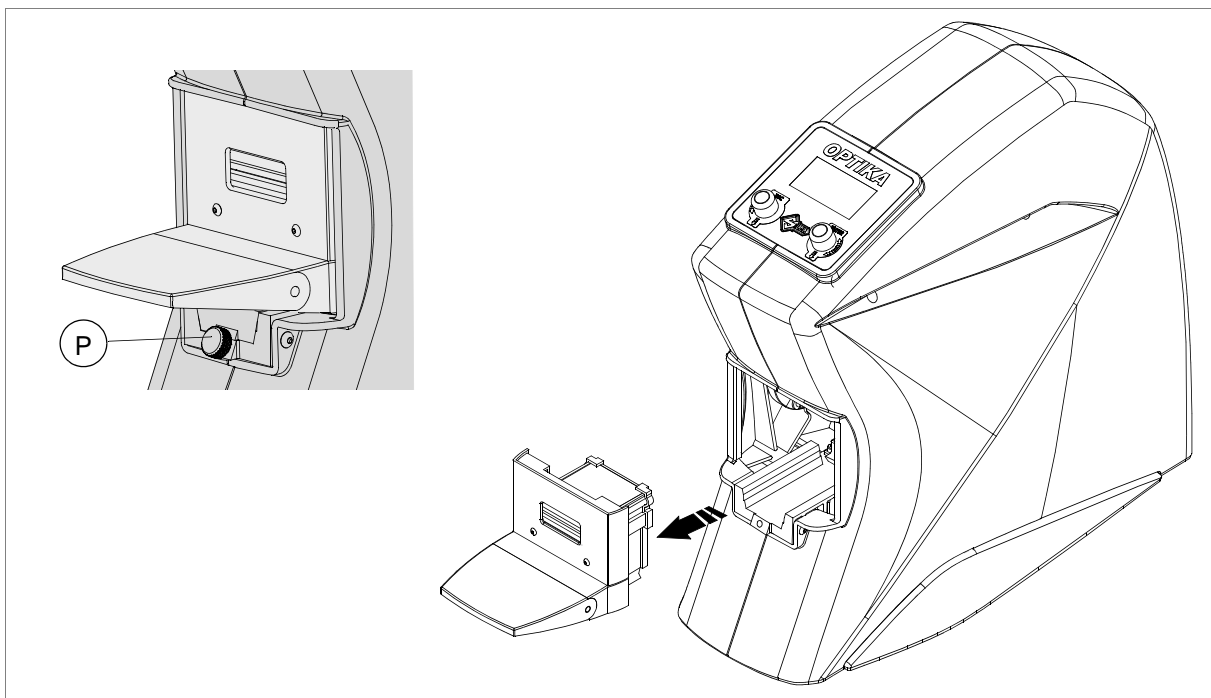

Fig. 42

7.2 Clamp cleaning

- 1) Disconnect the machine power cable.
- 2) Remove the clamp (see ch. 7.1, page 46).
- 3) Clean the key plate using the brush provided (see ch. 2, page 4). To simplify this operation turn the clamp upside-down.

7.3 Check machine gauging

With device connected, fit the (Z23) template into the clamp (see ch.6.4.7.1, ch.6.4.7.2, and ch.6.4.7.3).

7.4 Knob replacement (ESC/ENTER)

- 1) Unplug the power supply unit
- 2) Pull the knob upwards (simply pressed in).
- 3) Fit the new knob, paying attention to the shaped part of the pin.

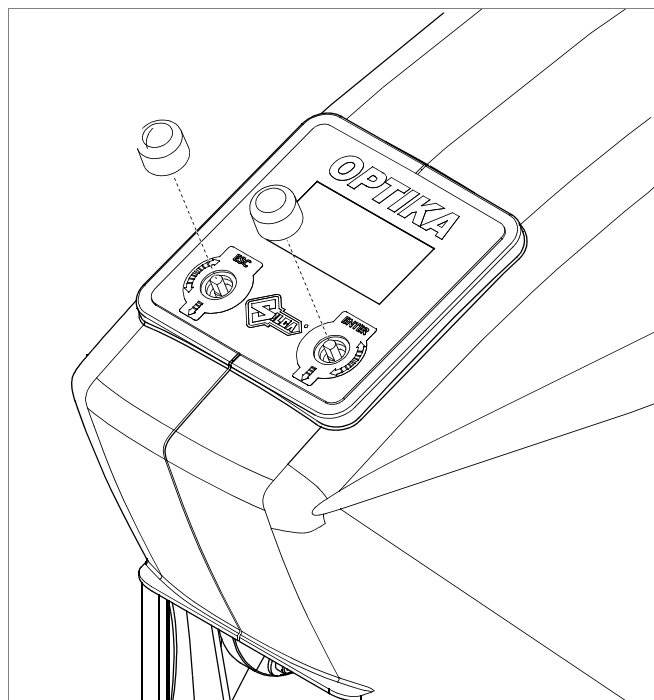

Fig. 43

8 DISPOSAL

For correct disposal please refer to current standards.

INFORMATION FOR USERS OF PROFESSIONAL EQUIPMENT



From "Actuation of Directive 2012/19/EU regarding Waste Electrical and Electronic Equipment (WEEE)"

The symbol of a crossed waste bin found on equipment or its packing indicates that at the end of the product's useful life it must be collected separately from other waste so that it can be properly treated and recycled.

In particular, separate collection of this professional equipment when no longer in use is organised and managed:

- a) directly by the user when the equipment was placed on the market before 31 December 2010 and the user personally decides to eliminate it without replacing it with new equivalent equipment designed for the same use;
- b) by the manufacturer, that is to say the subject which was the first to introduce and market new equipment that replaces previous equipment, when the user decides to eliminate equipment placed on the market before 31 December 2010 at the end of its useful life and replace it with an equivalent product designed for the same use. In this latter case the user may ask the manufacturer to collect the existing equipment;
- c) by the manufacturer, that is to say the subject which was the first to introduce and market new equipment that replaces previous equipment, if it was placed on the market after 31 December 2010;

Suitable separate collection for the purpose of forwarding discarded equipment for recycling, treatment or disposal in an environmentally friendly way helps to avoid possible negative effects on the environment and human health and encourages re-use and/or recycling of the materials making up the equipment.

The sanctions currently provided for by law shall apply to users who dispose of products in unauthorised ways.

9 AFTER-SALES SERVICE

Silca provides full service to purchasers of the OPTIKA device.

To ensure complete safety for the operator and machine, any job not specified in this manual should be carried out by the manufacturer or in a Silca authorized Service Centre.

At the end of the manual there is a list of manufacturers' and authorized Service Centre addresses; if the manual was downloaded is necessary visit the website to see the contacts (www.silca.biz).

Silca undertakes to make consumables, optional items and spare parts available for the limited time defined in its product obsolescence policy.

9.1 How to request service

The guarantee attached to the OPTIKA device ensures free repairs or replacements of faulty parts within 24 months of purchase. All other service calls must be arranged by the customer with Silca or with a Silca authorized Service Centre.

Appendix 1 - ELECTRICAL DIAGRAMS

The following pages contain the electrical diagrams for the OPTIKA device described in this manual.

OPTIKA

ELECTRICAL DIAGRAMS

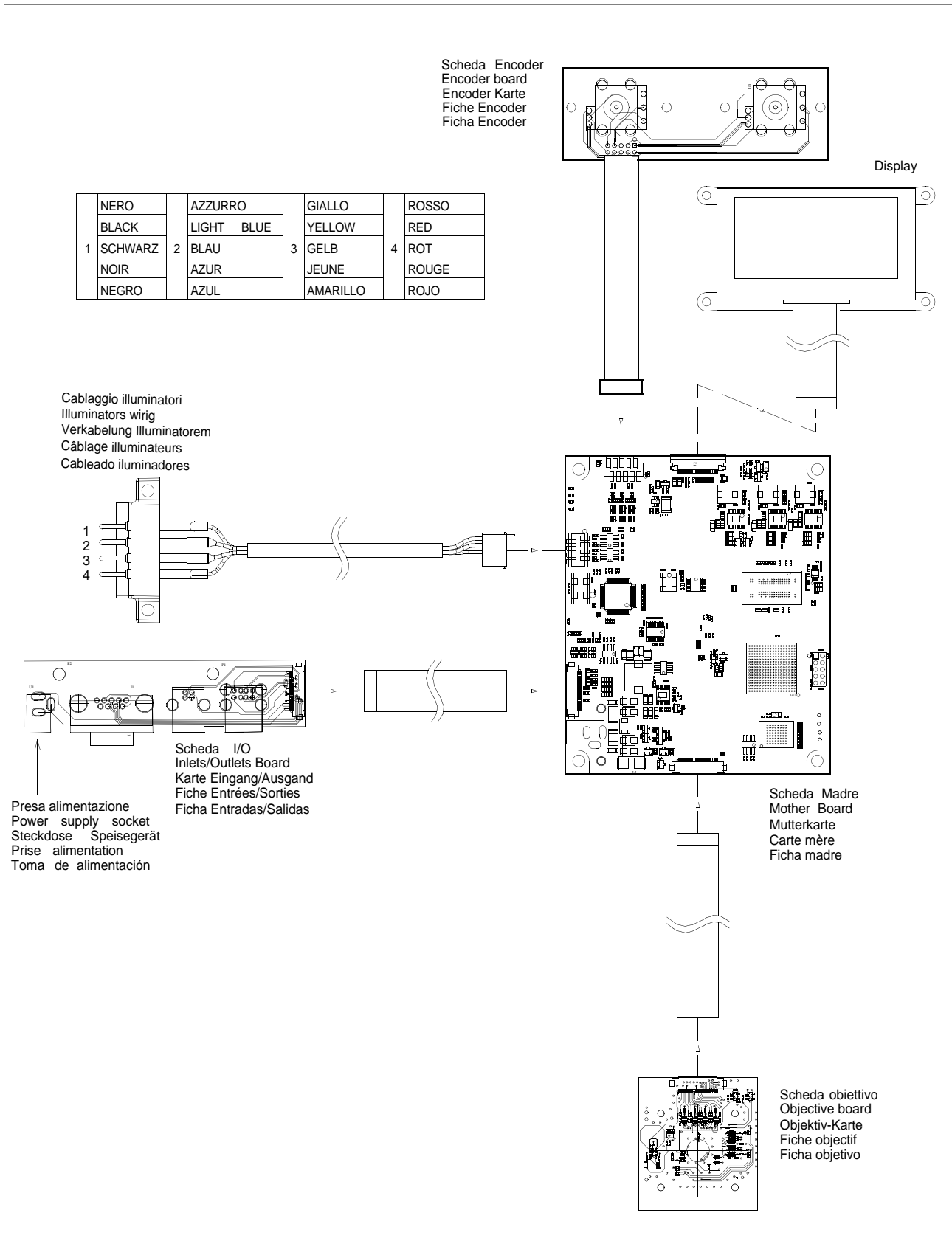

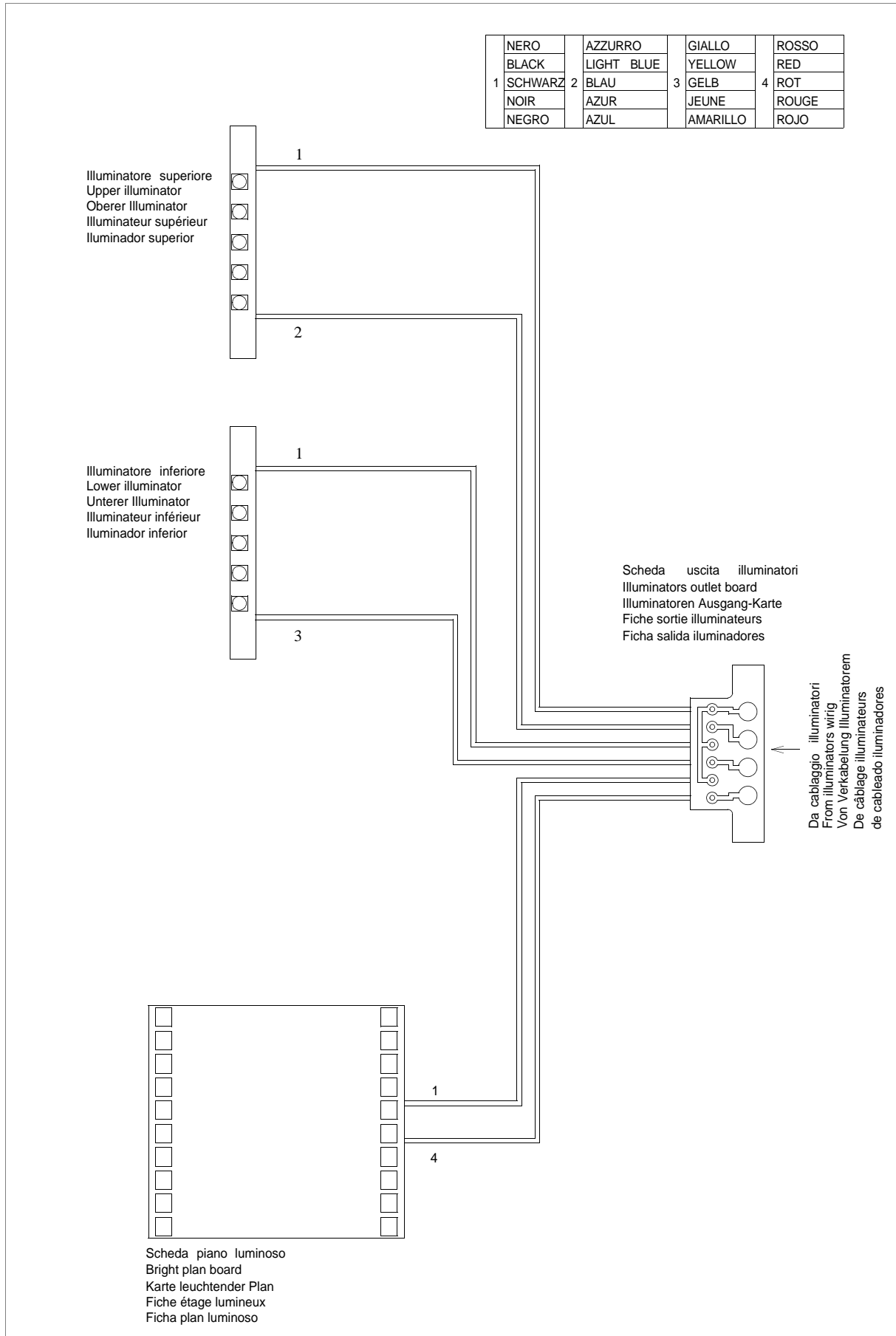



VITTORIO VENETO 04/01/2010

CE DECLARATION OF MACHINE COMPLIANCE

**SILCA S.p.A. - VIA PODGORA 20 (Z.I.)
31029 VITTORIO VENETO (TV) - (ITALY)
TEL. 0438 9136 - FAX. 0438 913800**

Declares under its own responsibility that the **Reader** model

OPTIKA

complies with the requirements of the following European Directives:

European Union **DIRECTIVE 2004/108/CE** (Electromagnetic Compatibility)
and with the EN 55022 - EN 55024
EN 61000-3-2 - EN 61000-3-3 Standards

General Manager Basic Production Center

Stefano Setti

SILCA S.p.A.
Via Podgora, 20 (Z.I.)
31029 Vittorio Veneto (TV) Italy

A Member of the Kaba Group

Tel. +39 0438 9136 Fax +39 0438 913800 www.silca.it info@silca.it
P. IVA C.F. e Reg. Impr. IT03286730266 REA TV 258111
Cap. Soc. € 10.000.000 i.v. Export TV 038851

Società soggetta a direzione e coordinamento di Kaba Holding AG, con sede in Rümlang (Svizzera),
Hofwisenstrasse 24, ai sensi e per gli effetti degli articoli 2497 - 2497sexies del Codice Civile.

